

Name: \_\_\_\_\_

# Trace the Letter

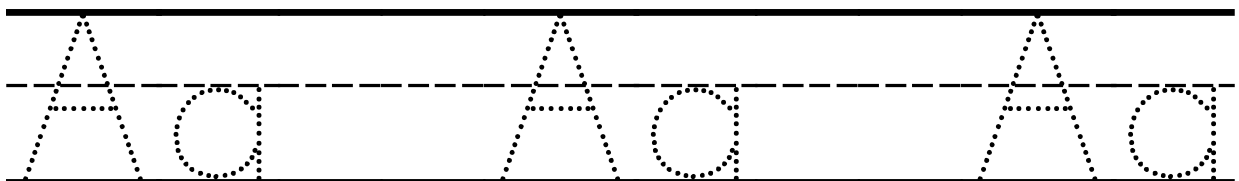
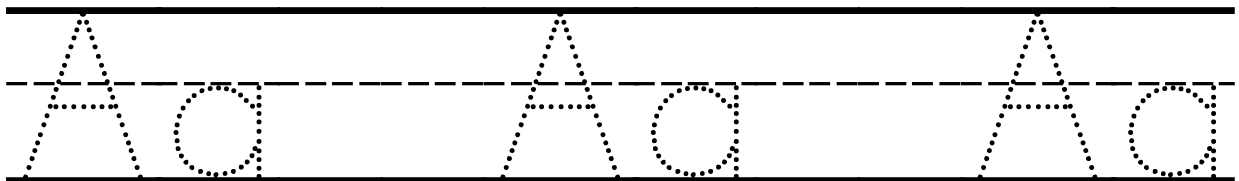
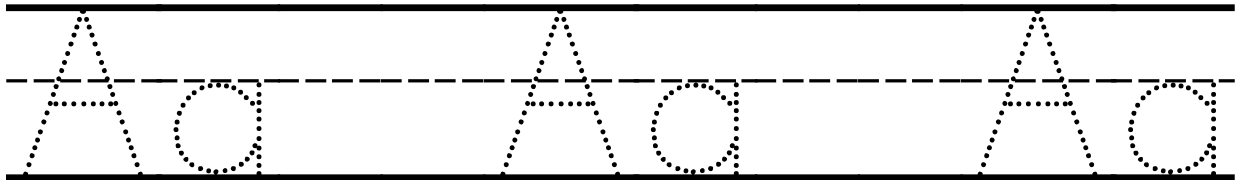
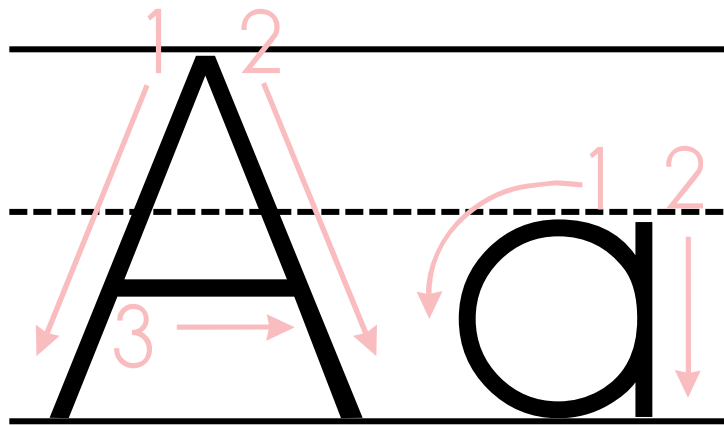

Name: \_\_\_\_\_

# Trace the Letter

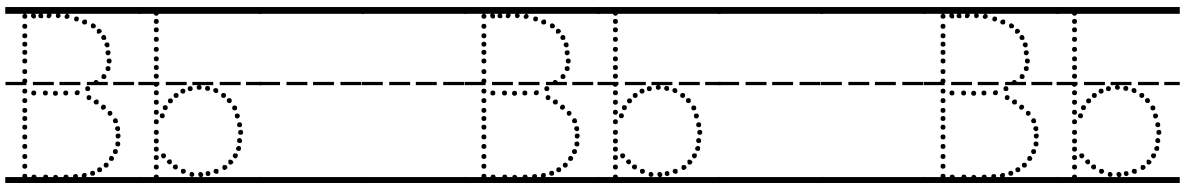
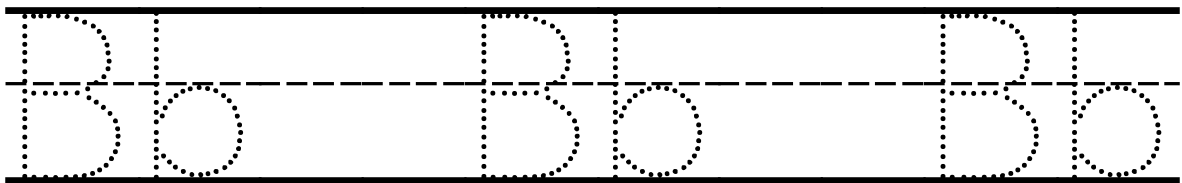
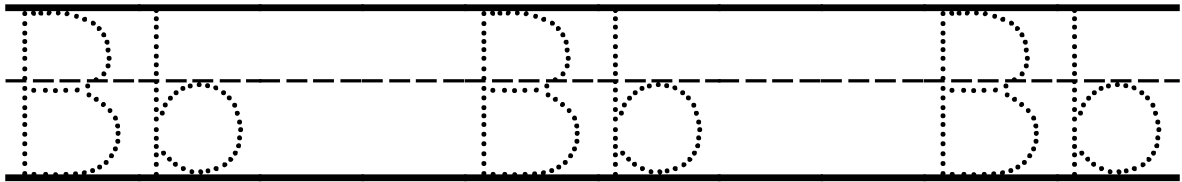
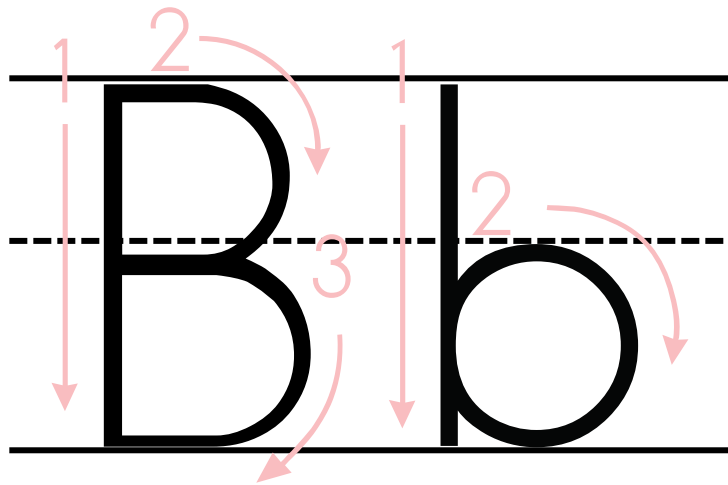

Name: \_\_\_\_\_

# Trace the Letter

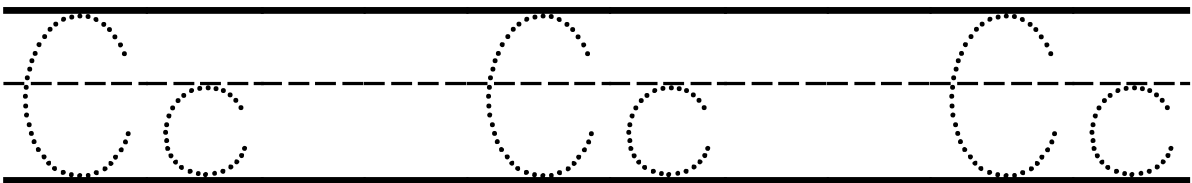
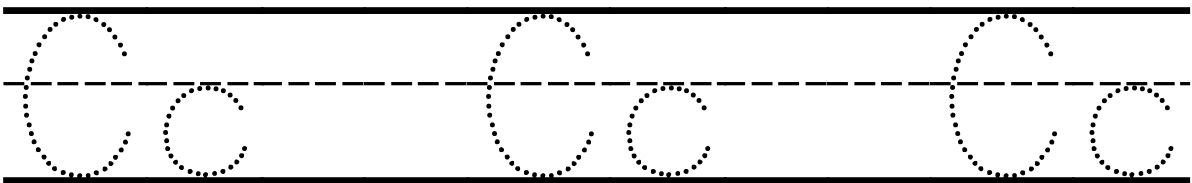
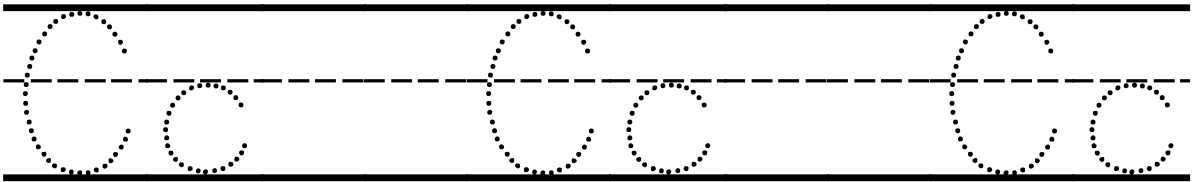
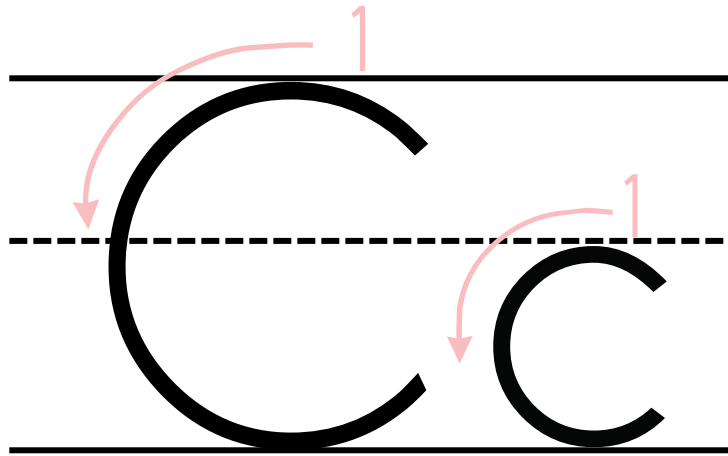

Name: \_\_\_\_\_

# Trace the Letter

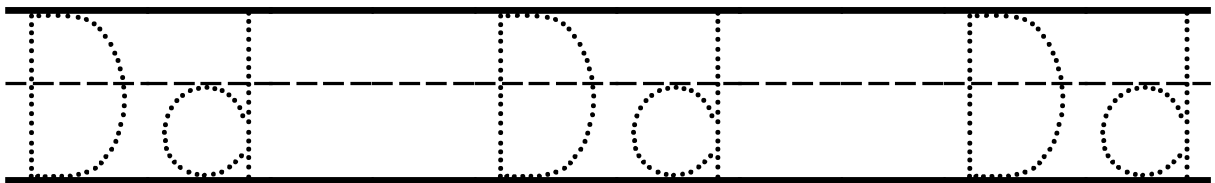
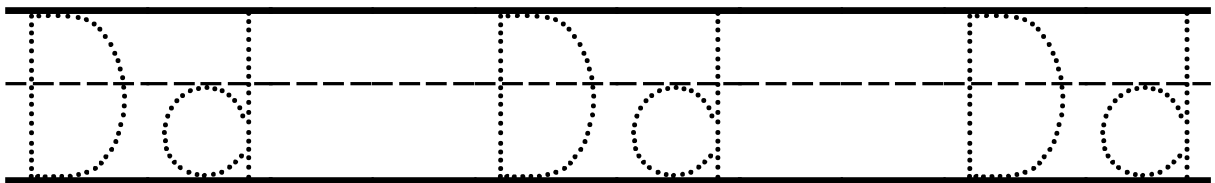
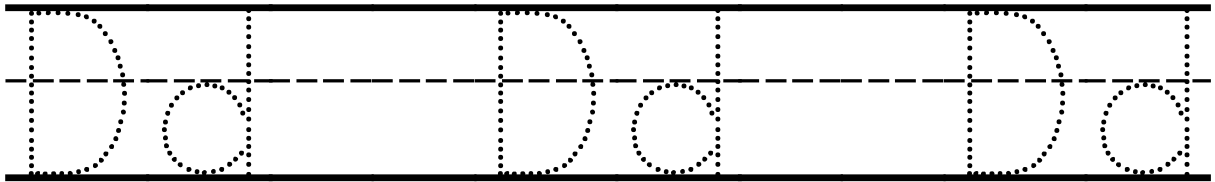
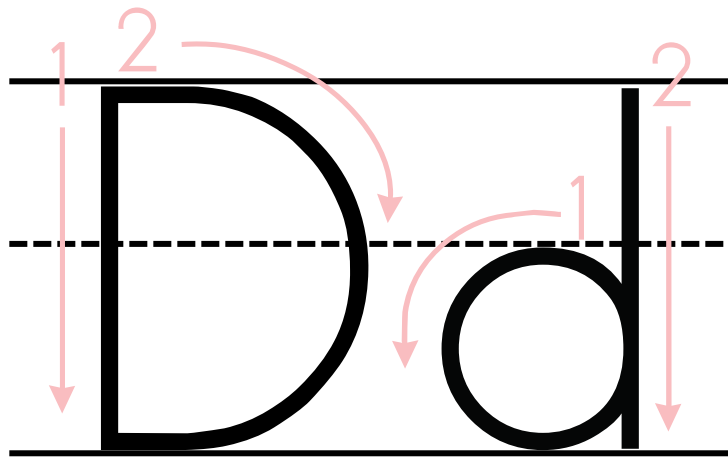

Name: \_\_\_\_\_

# Trace the Letter

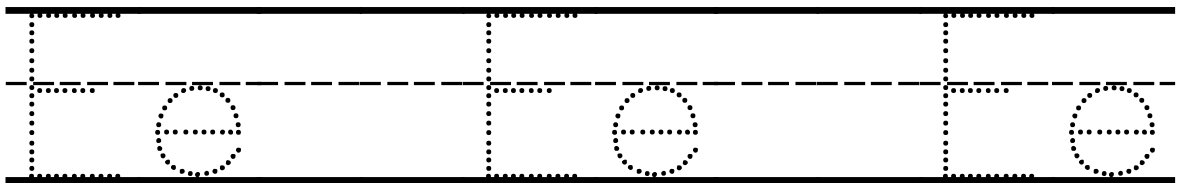
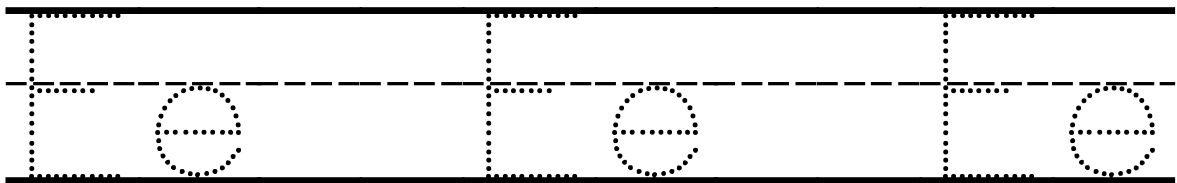
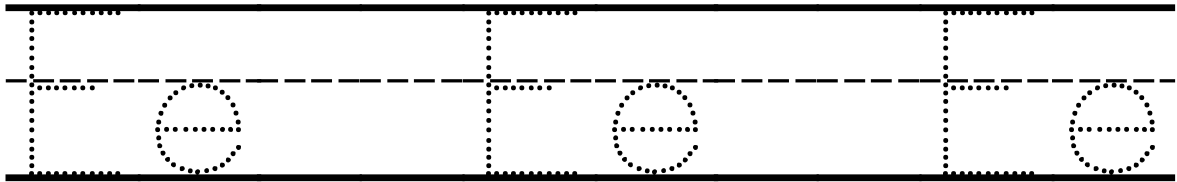
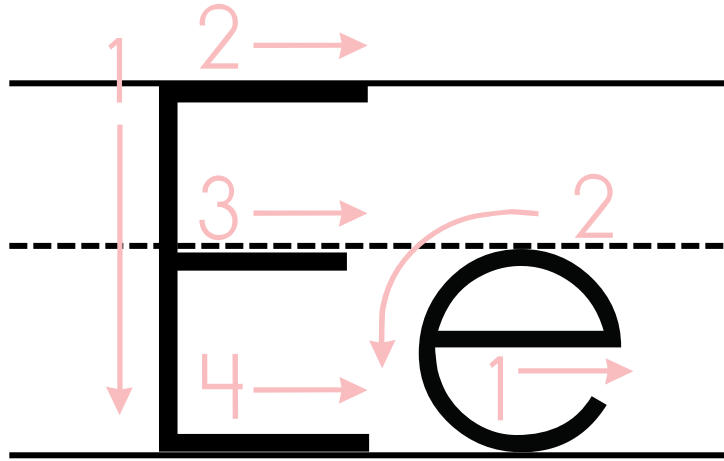

Name: \_\_\_\_\_

# Trace the Letter

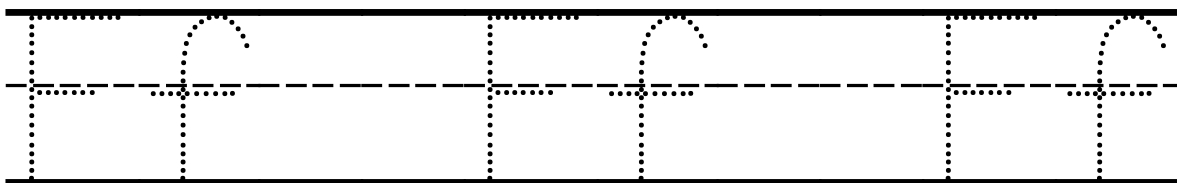
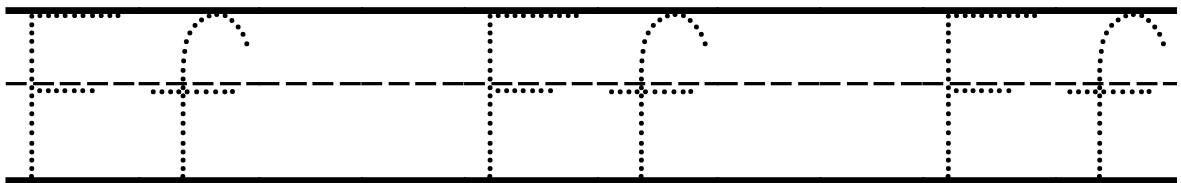
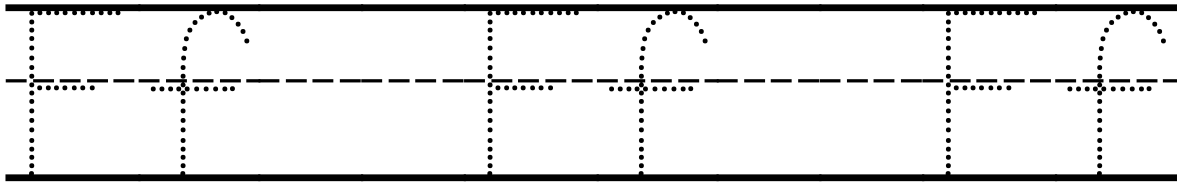
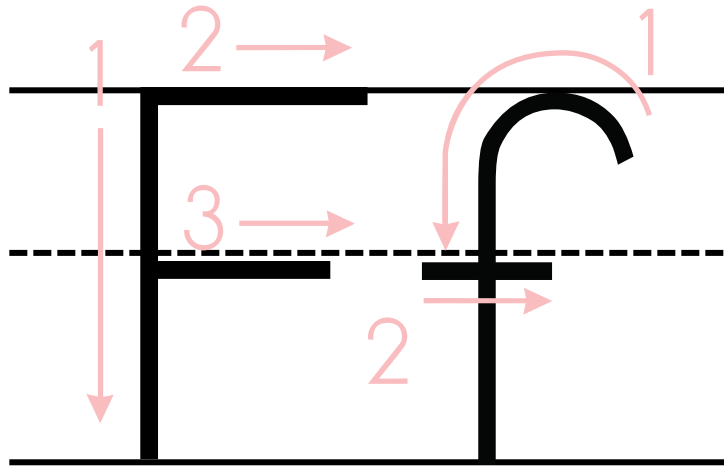

Name: \_\_\_\_\_

# Trace the Letter

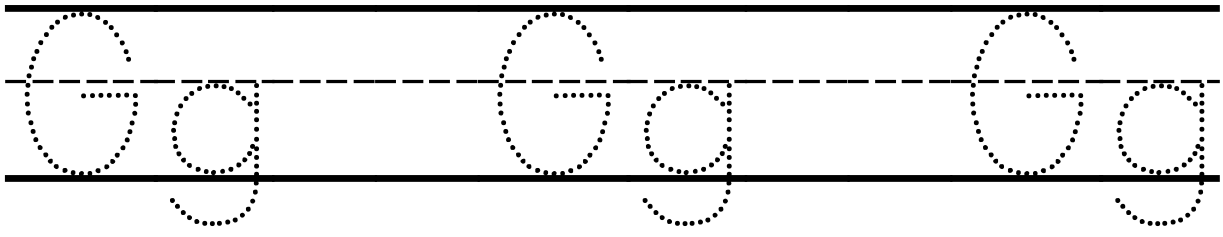
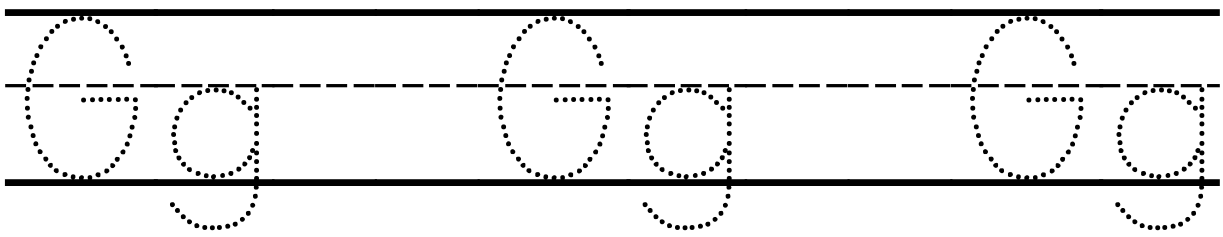
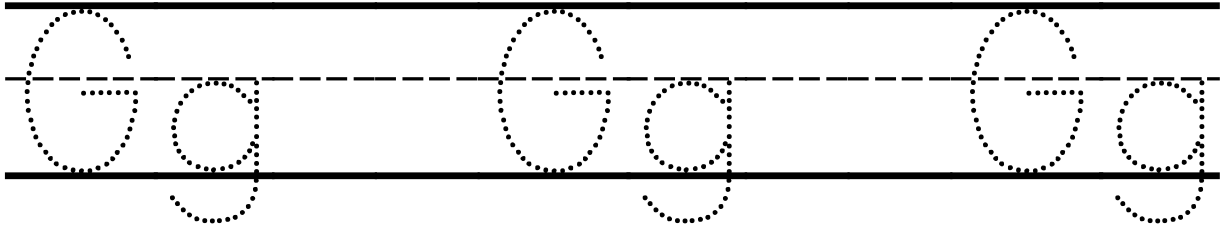
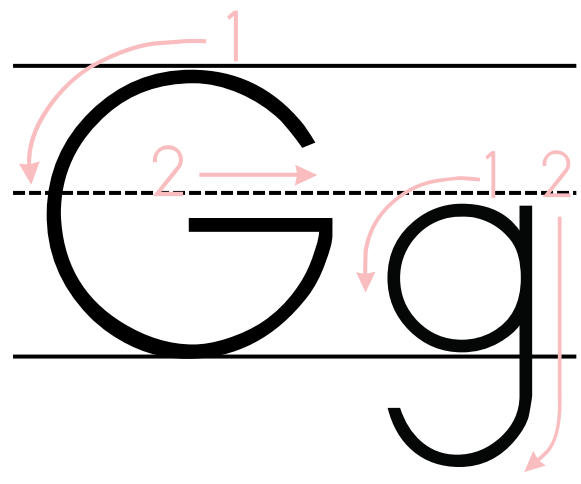

Name: \_\_\_\_\_

# Trace the Letter

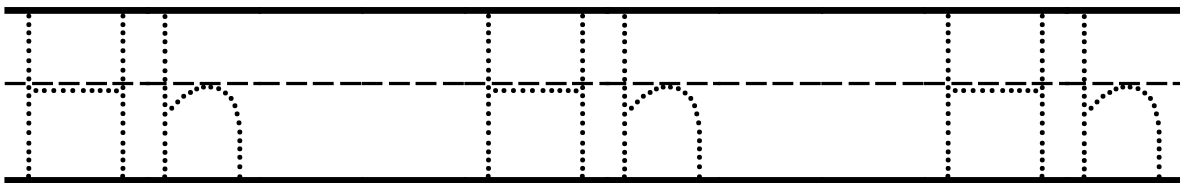
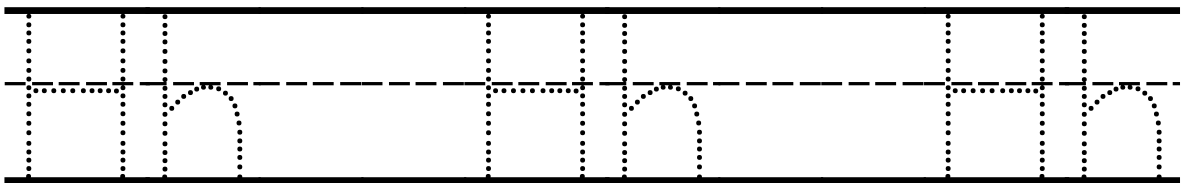
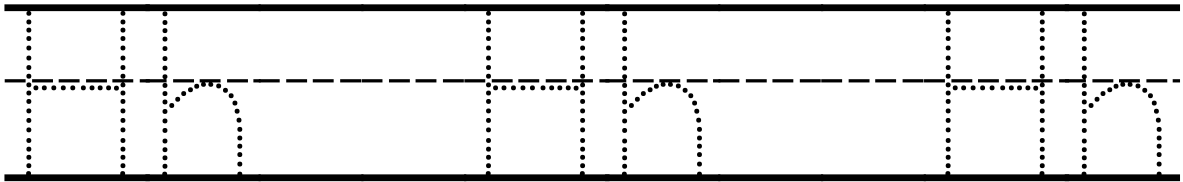
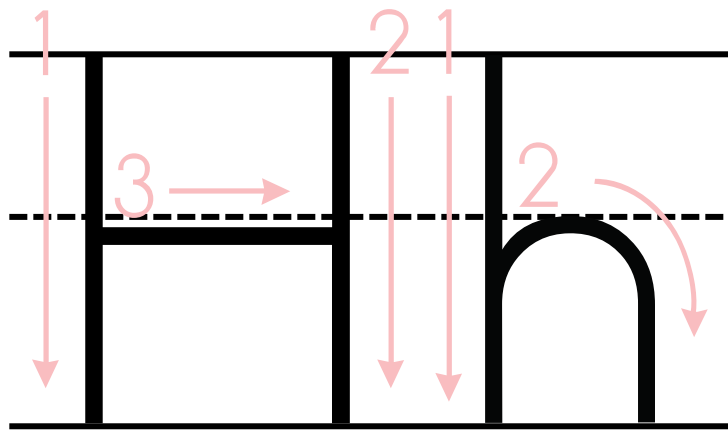



Name: \_\_\_\_\_

# Trace the Letter

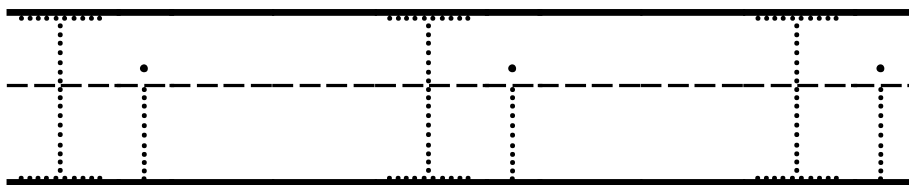
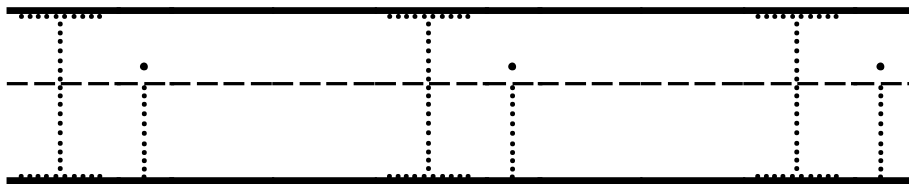
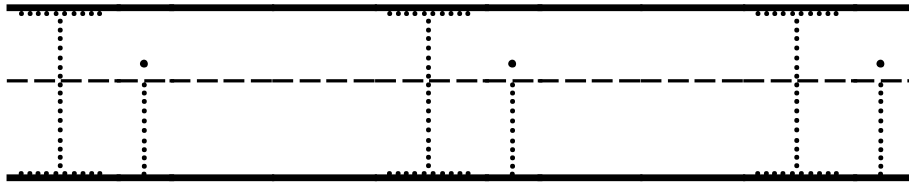
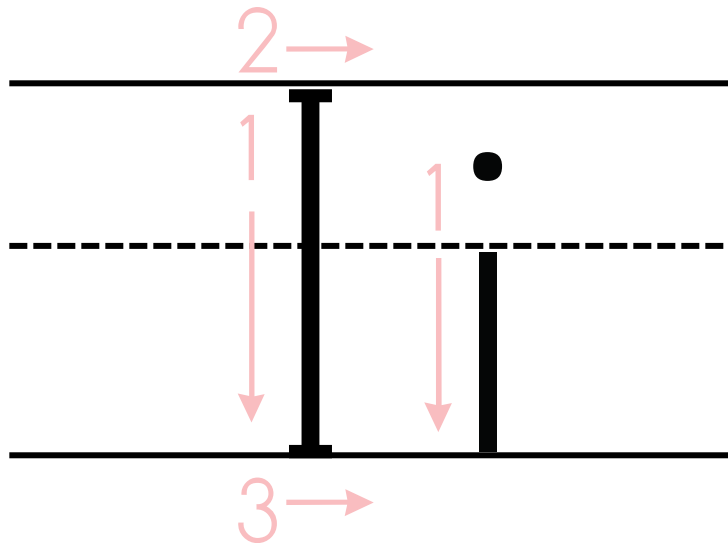

Name: \_\_\_\_\_

# Trace the Letter

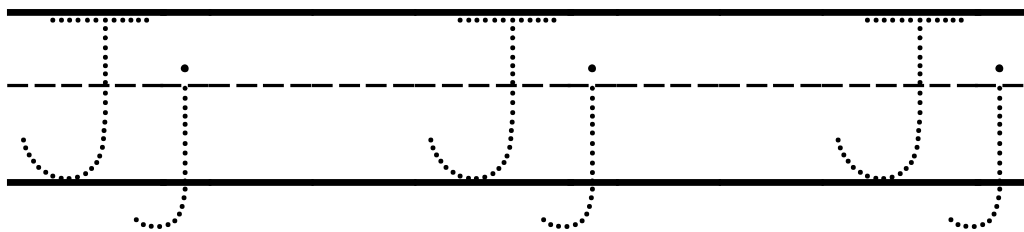
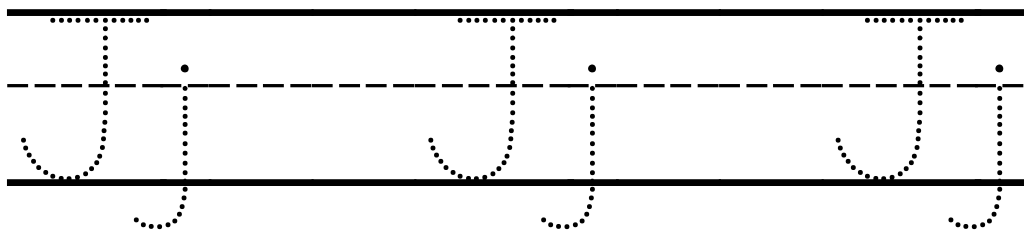
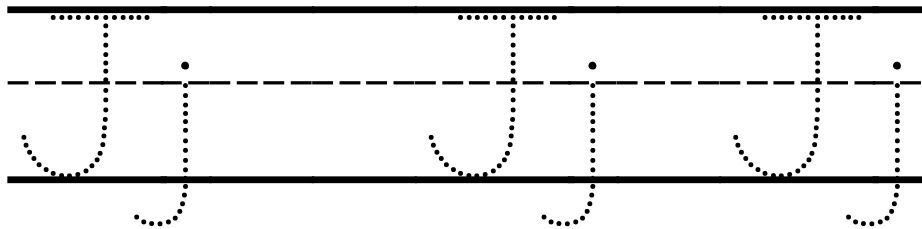
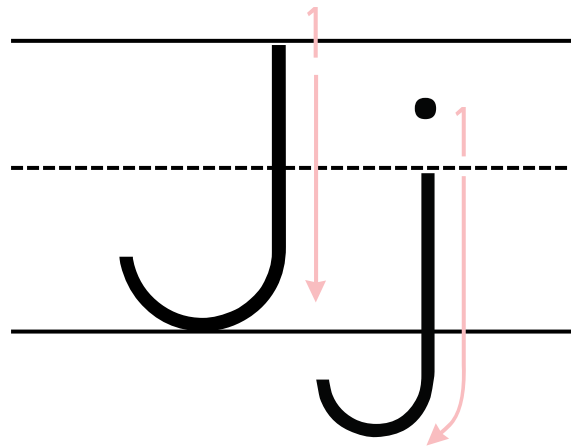

Name: \_\_\_\_\_

# Trace the Letter

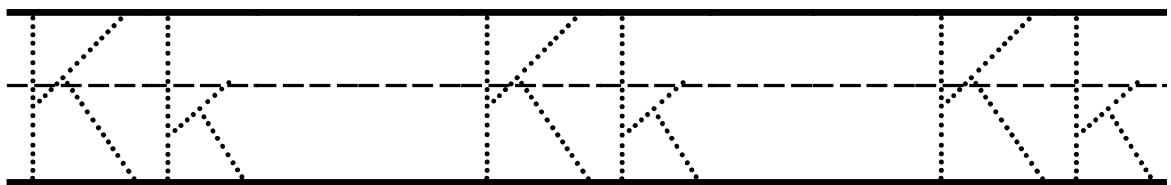
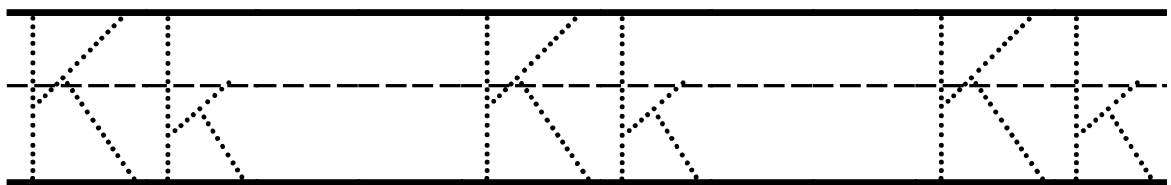
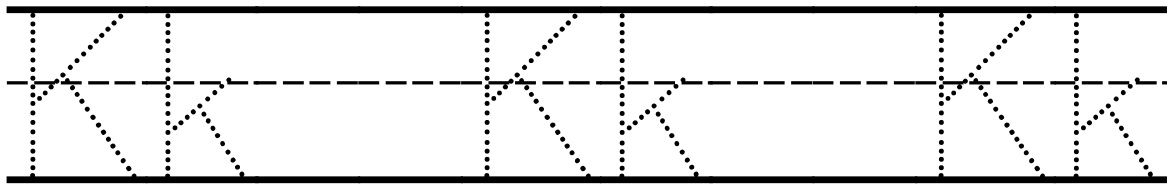
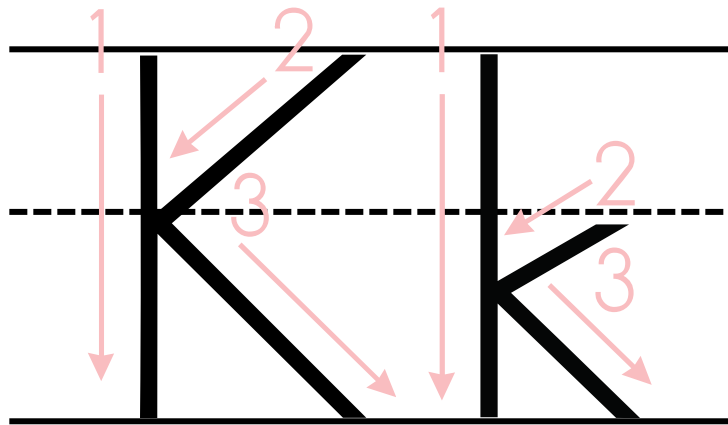

Name: \_\_\_\_\_

# Trace the Letter

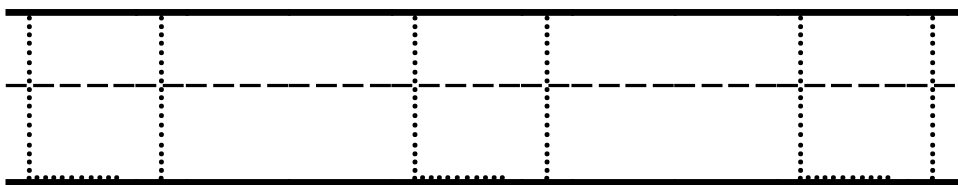
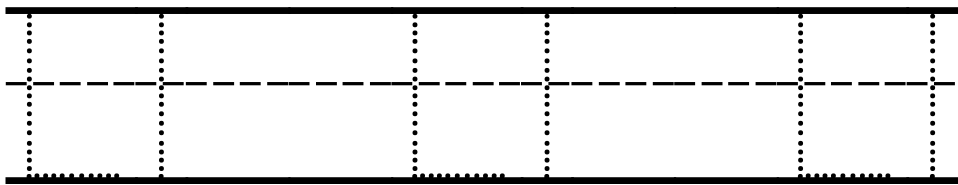
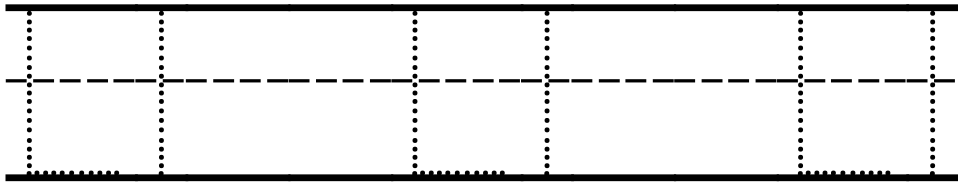
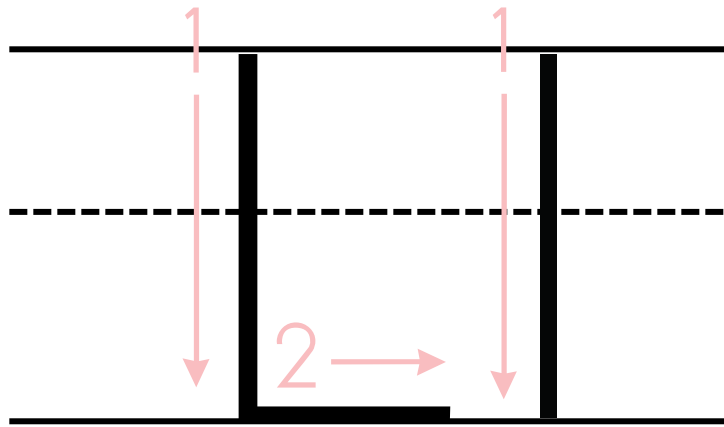

Name: \_\_\_\_\_

# Trace the Letter

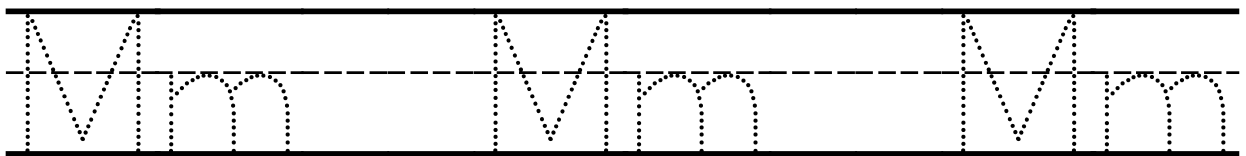
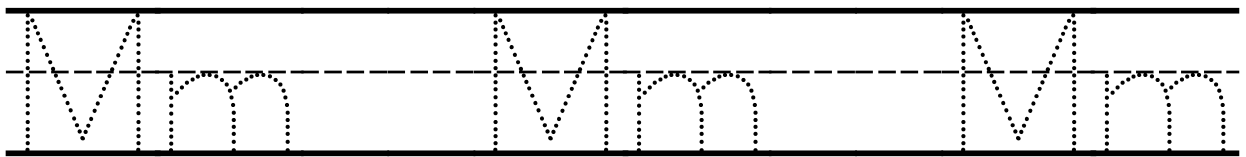
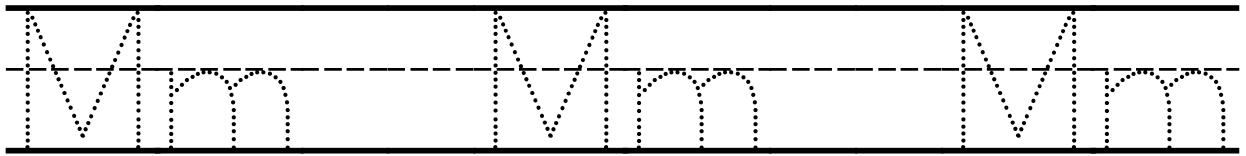
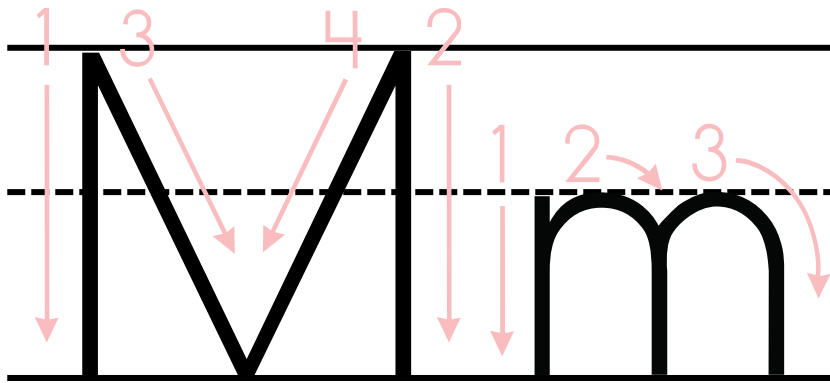

Name: \_\_\_\_\_

# Trace the Letter

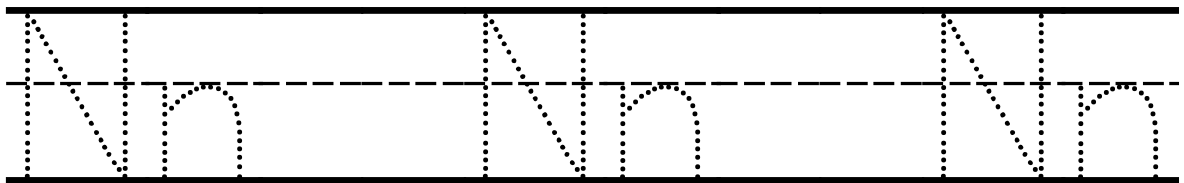
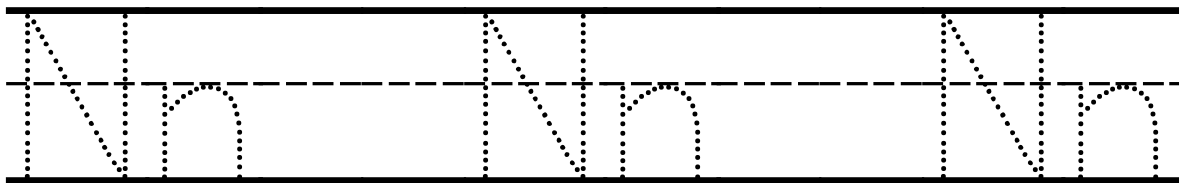
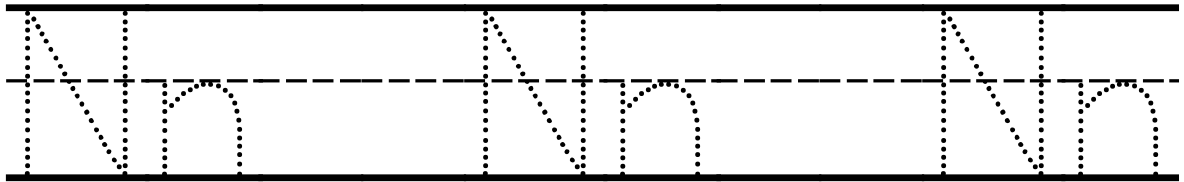
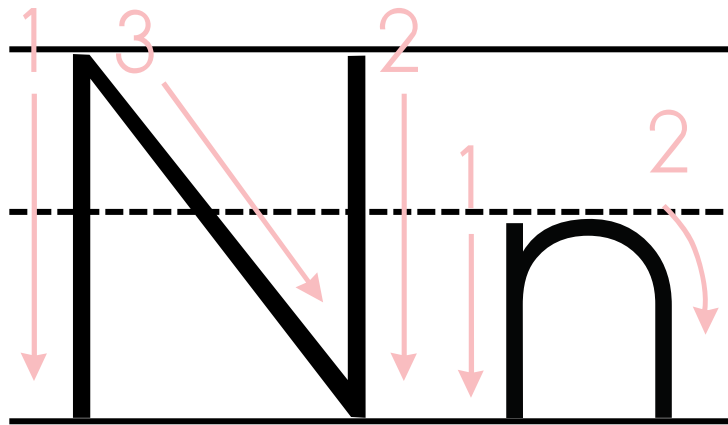

Name: \_\_\_\_\_

# Trace the Letter

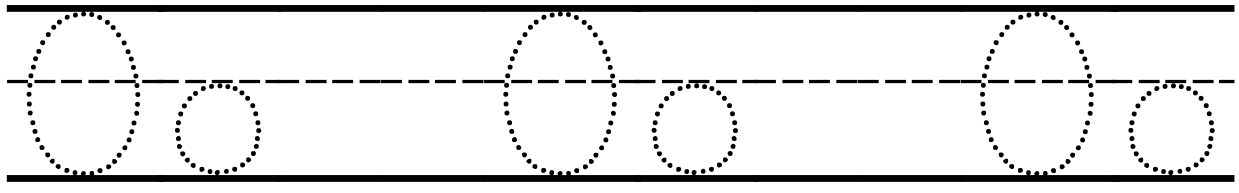
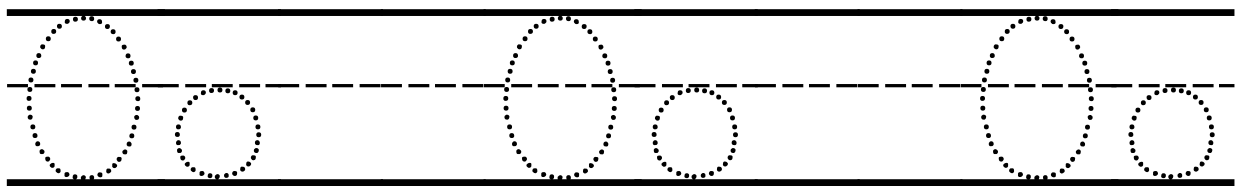
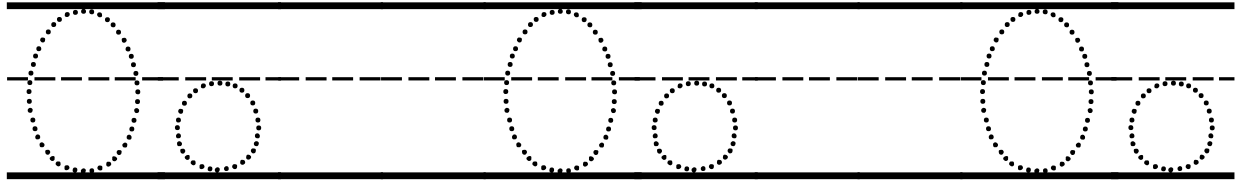
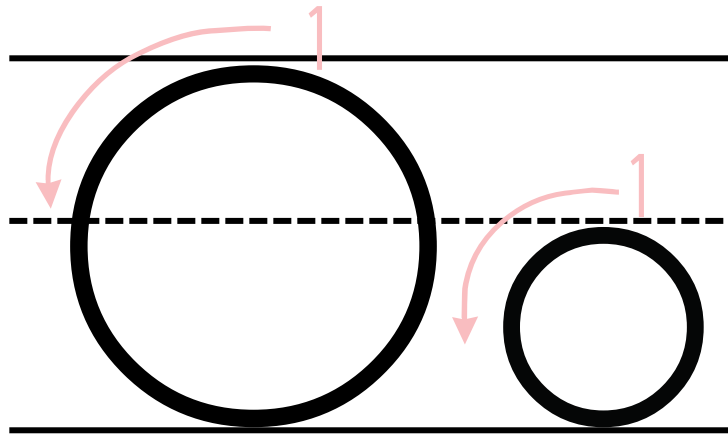

Name: \_\_\_\_\_

# Trace the Letter

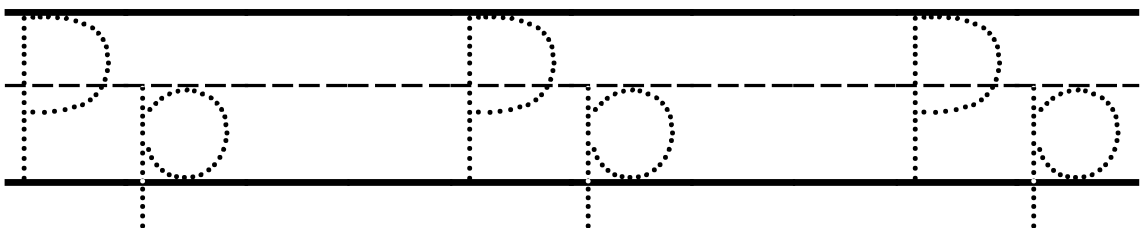
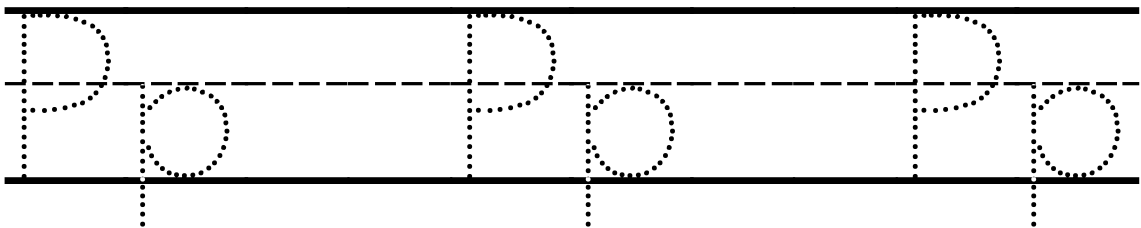
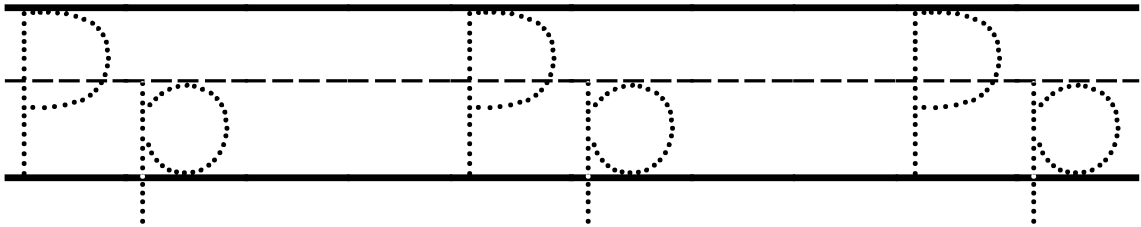
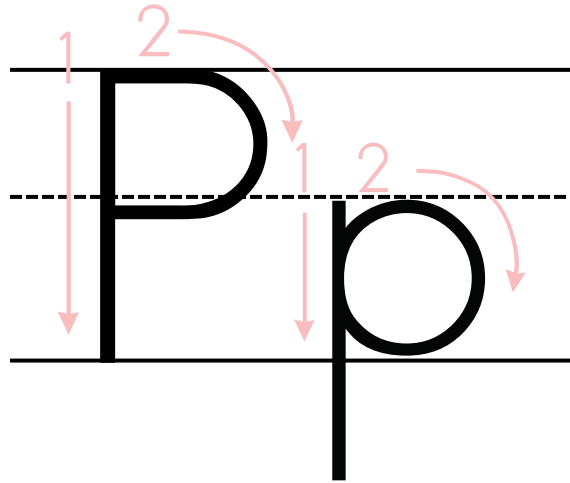



Name: \_\_\_\_\_

# Trace the Letter

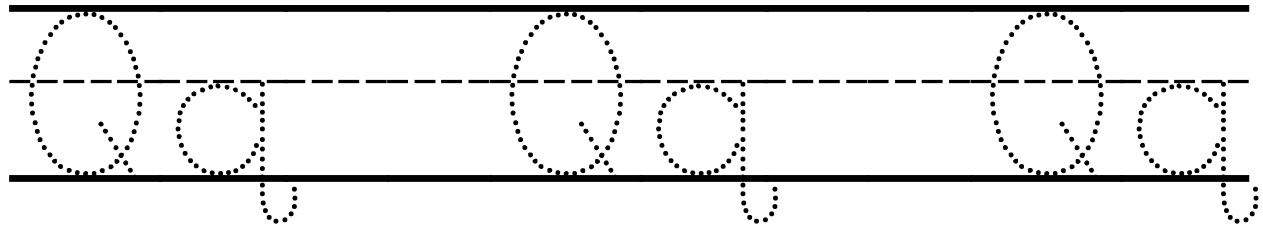
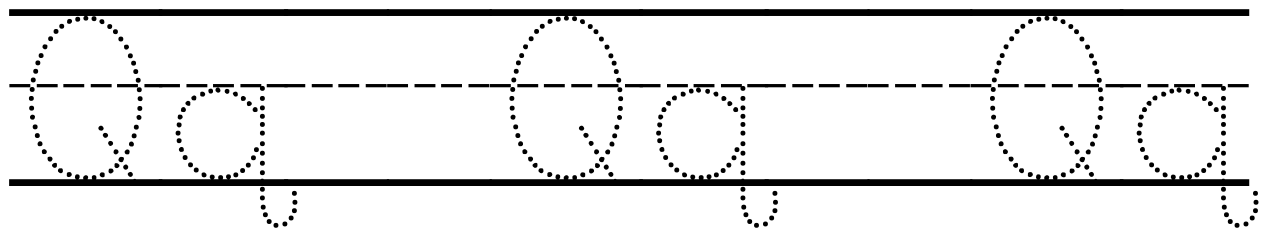
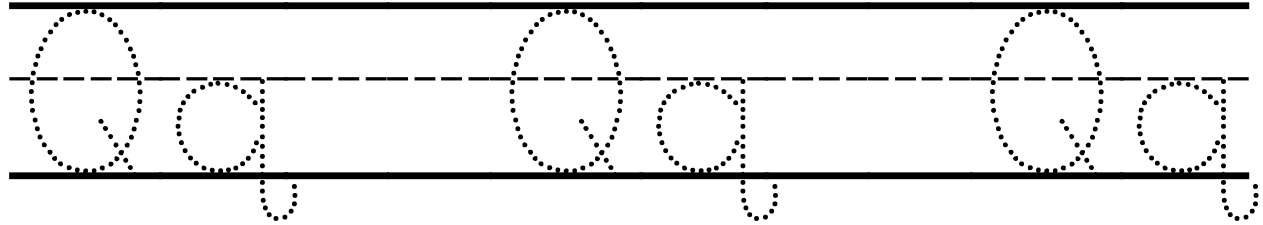
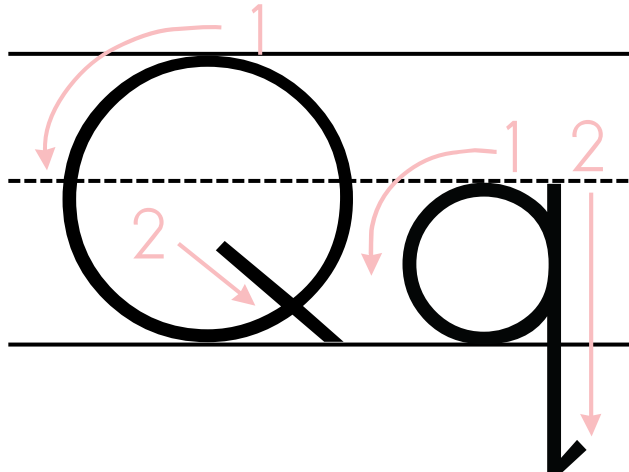

Name: \_\_\_\_\_

# Trace the Letter

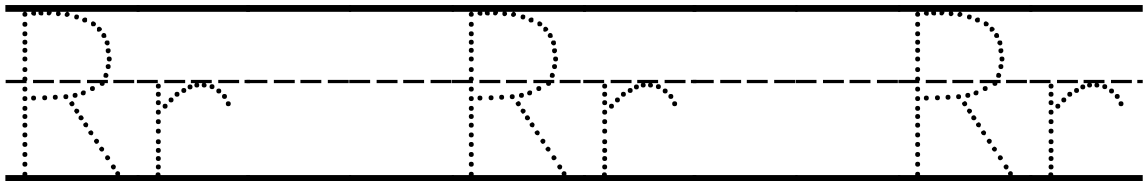
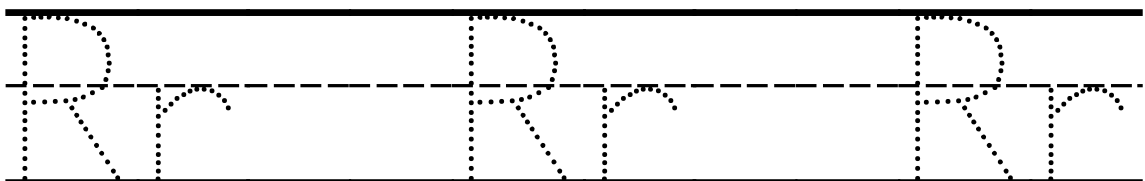
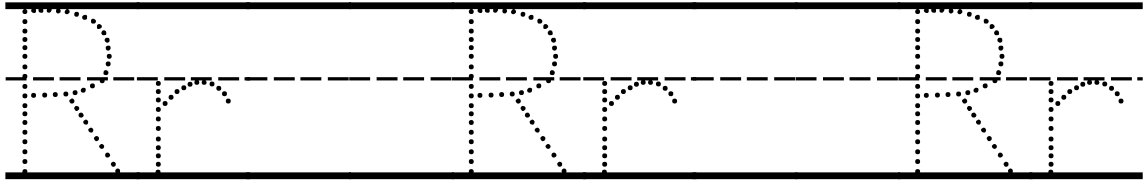
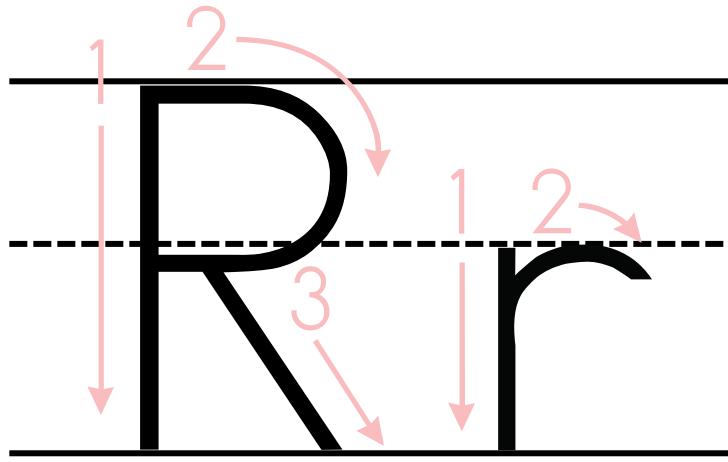

Name: \_\_\_\_\_

# Trace the Letter

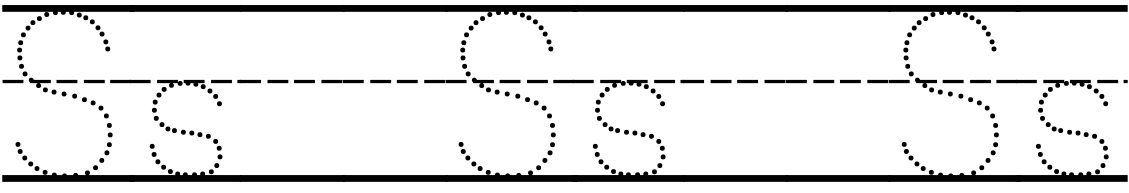
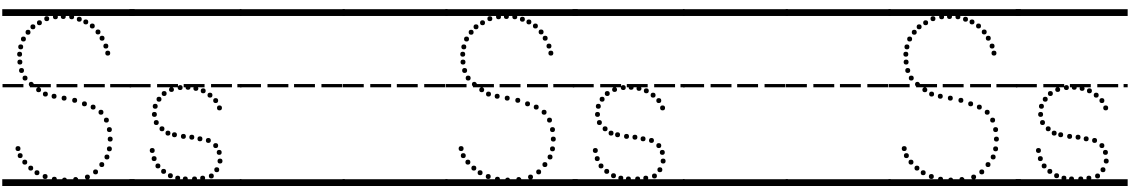
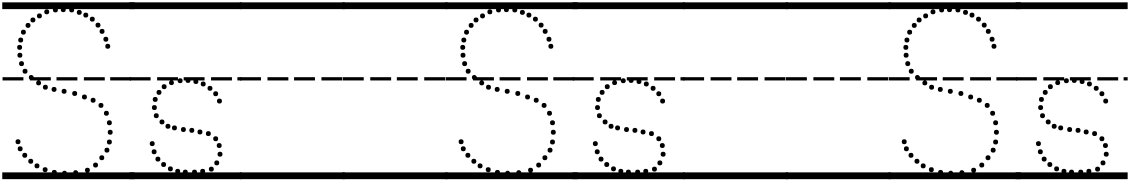
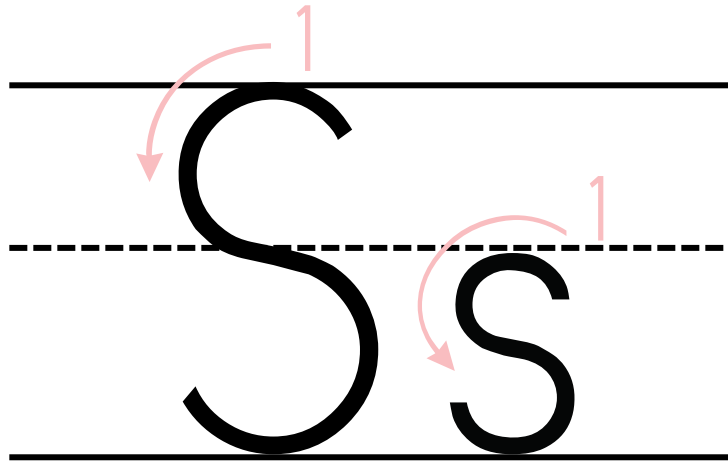

Name: \_\_\_\_\_

# Trace the Letter

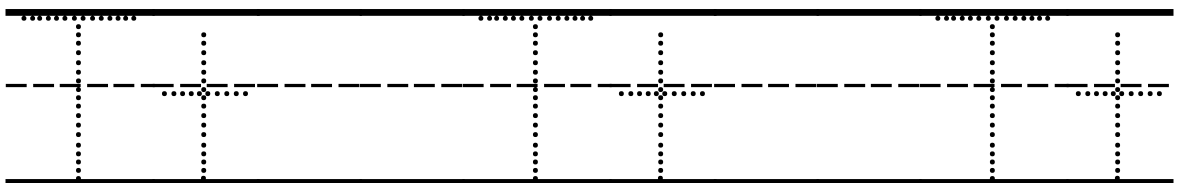
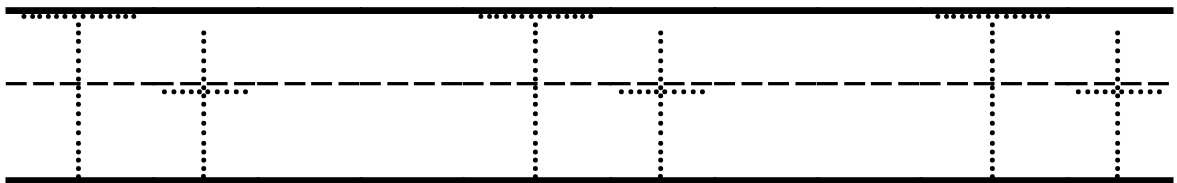
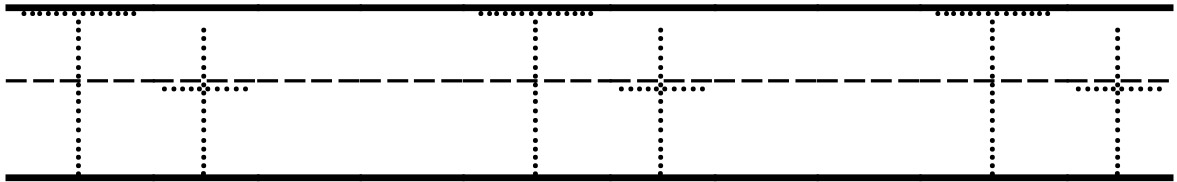
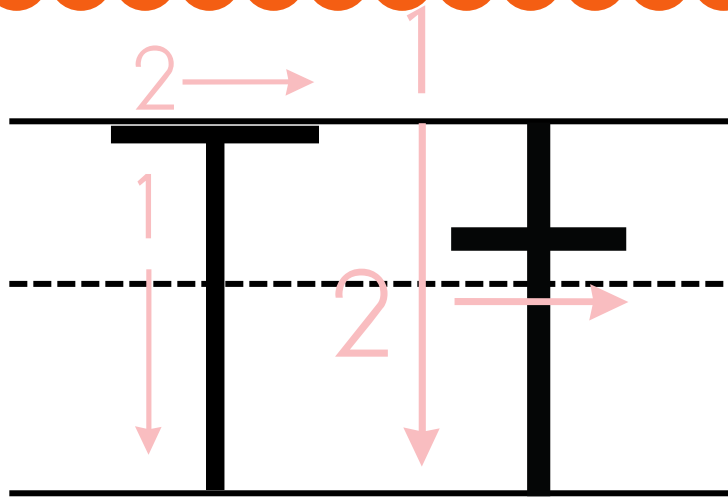

Name: \_\_\_\_\_

# Trace the Letter

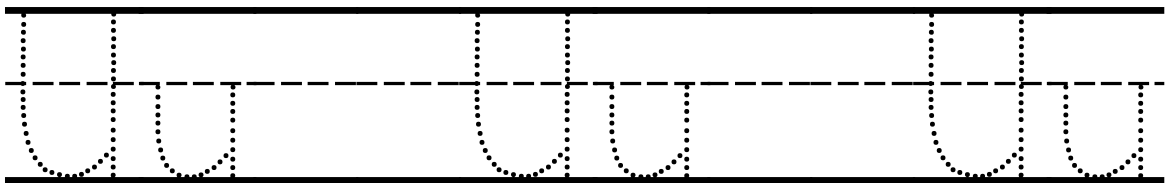
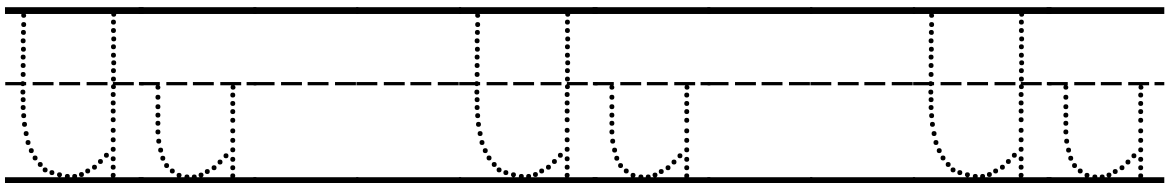
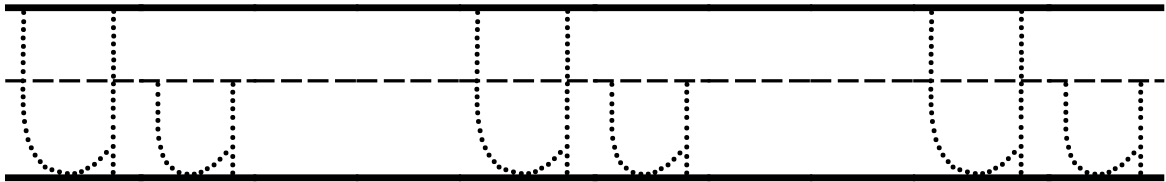
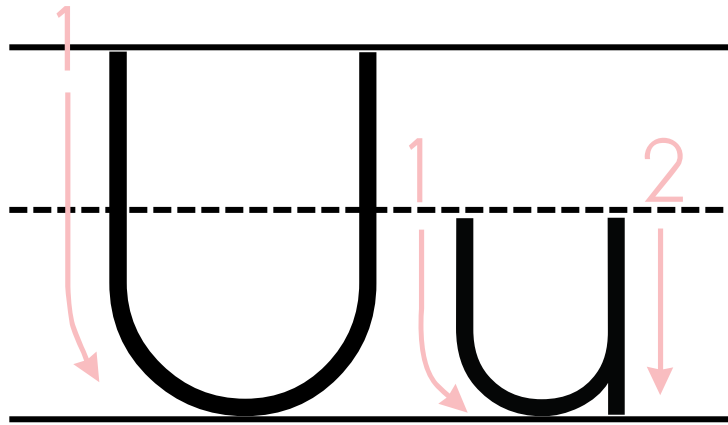

Name: \_\_\_\_\_

# Trace the Letter

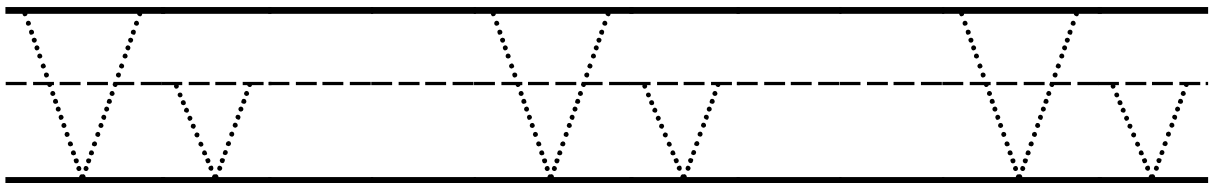
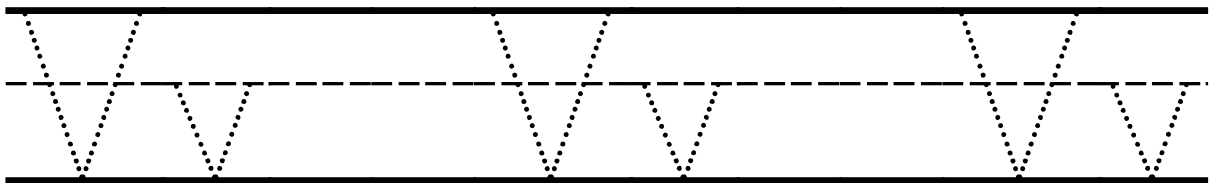
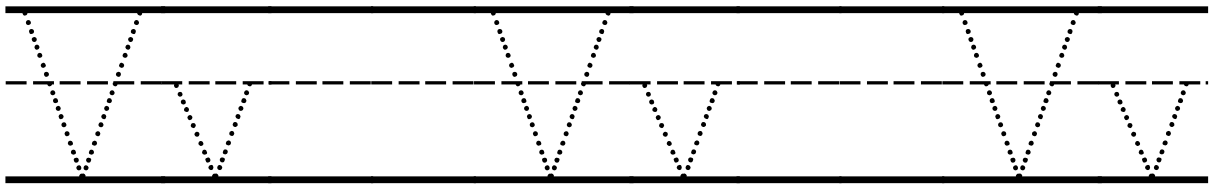
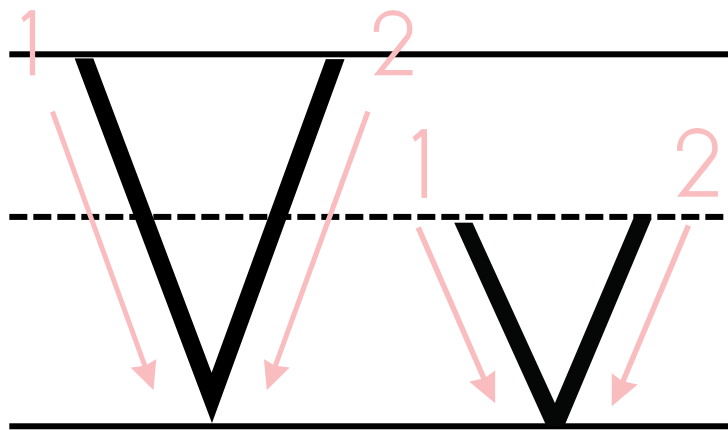

Name: \_\_\_\_\_

# Trace the Letter

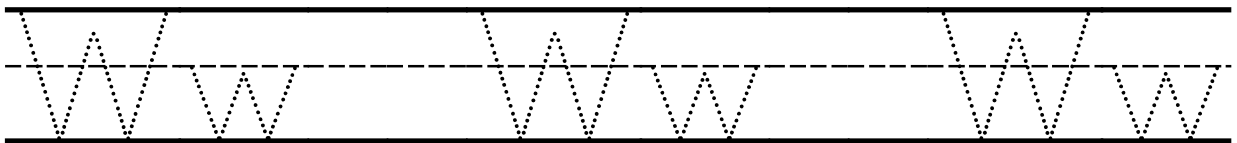
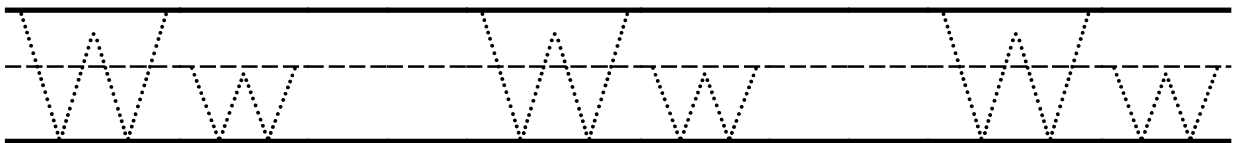
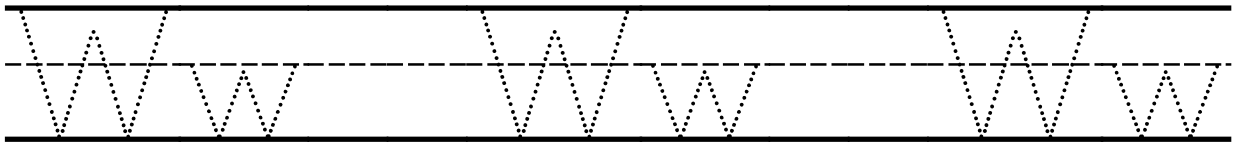
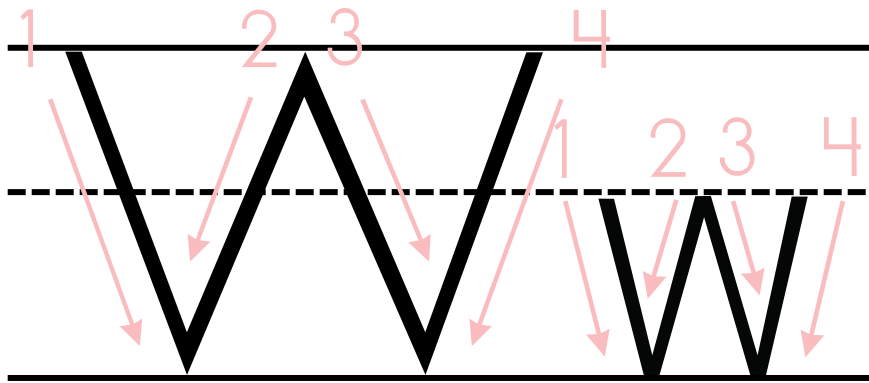

Name: \_\_\_\_\_

# Trace the Letter

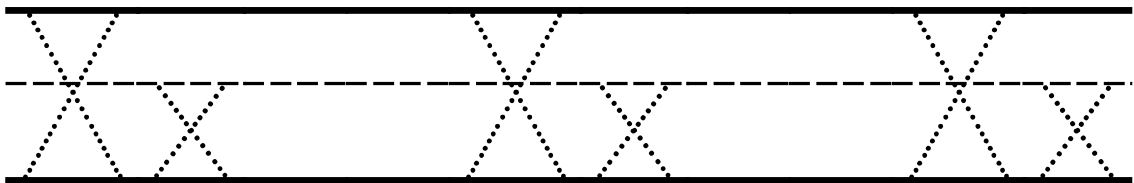
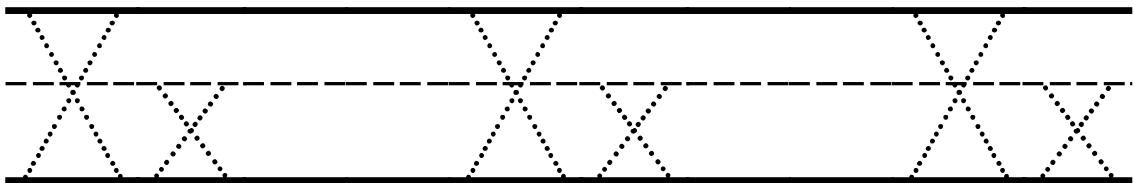
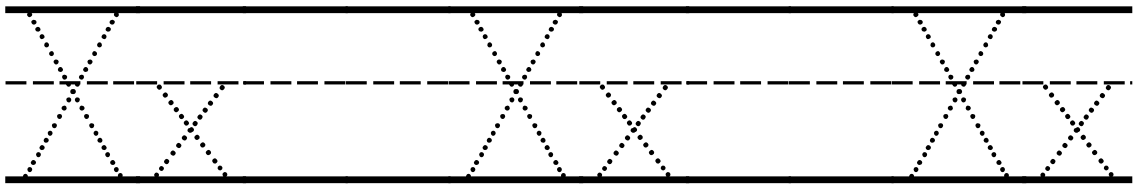
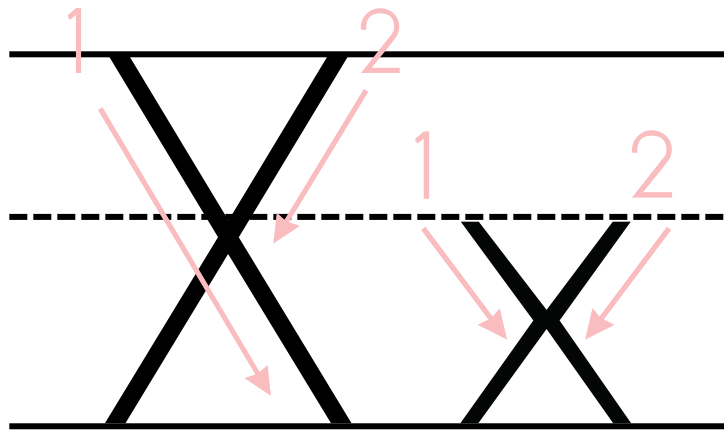



Name: \_\_\_\_\_

# Trace the Letter

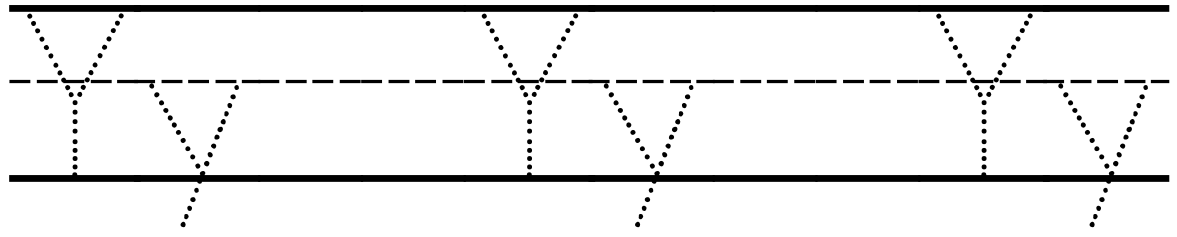
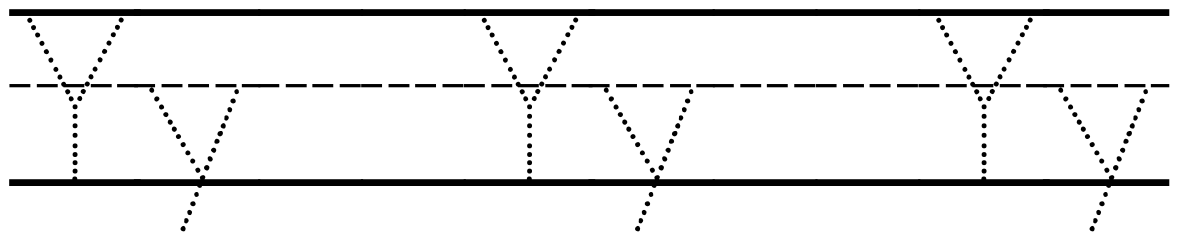
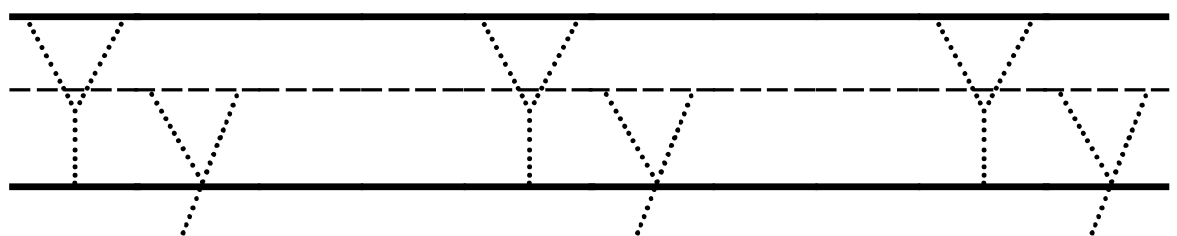
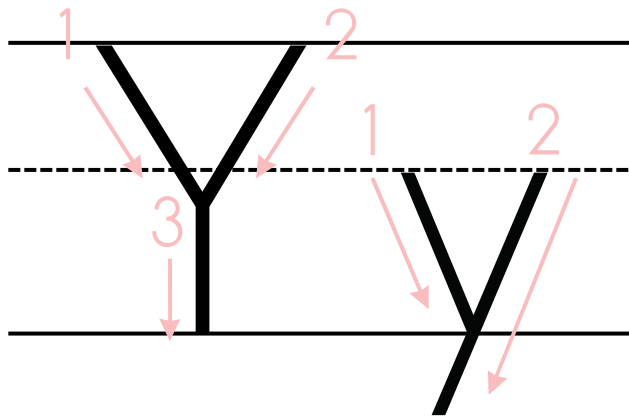

Name: \_\_\_\_\_

# Trace the Letter

