

Alphabet Tracing Worksheets

from Letter A to Letter Z

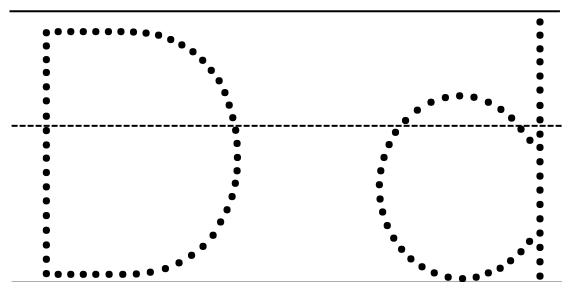
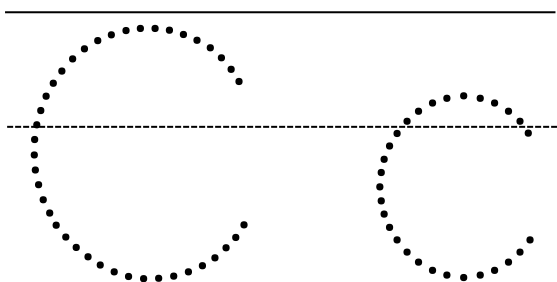
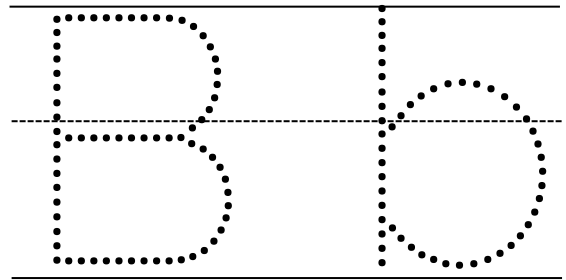
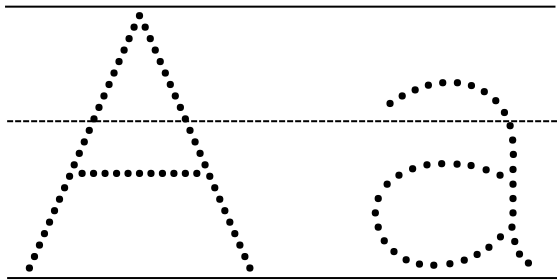
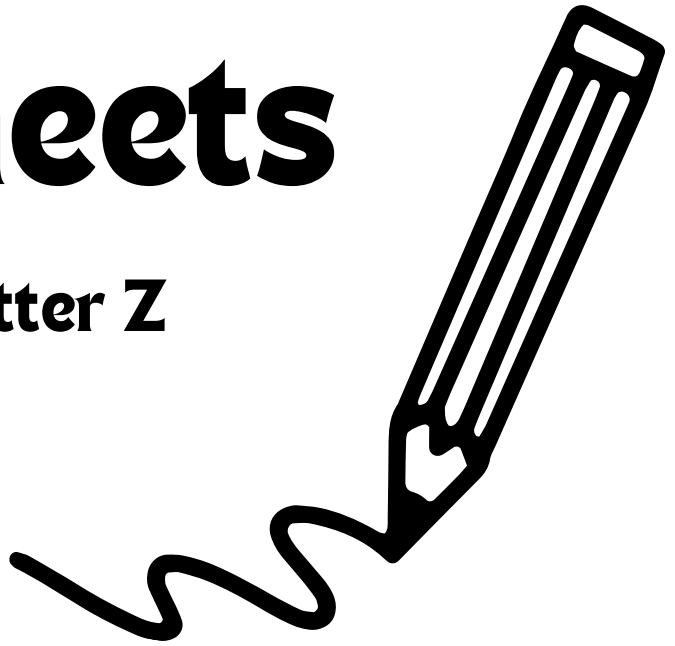

Name: _____

Letter Sounds



Directions: Color the picture, then trace the letter.

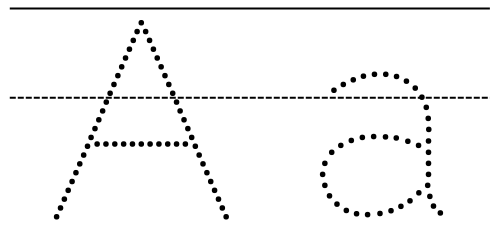
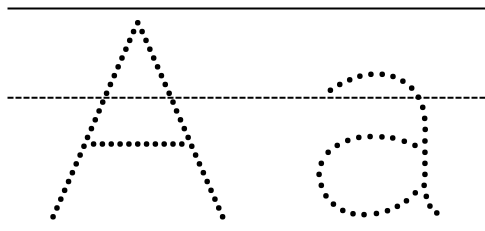
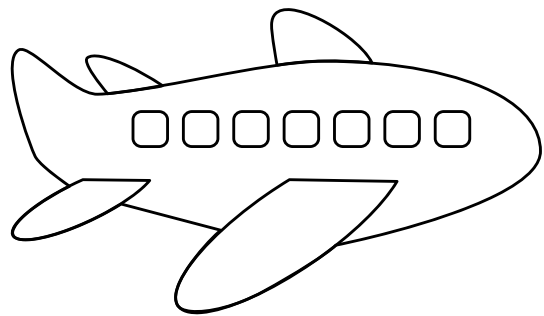
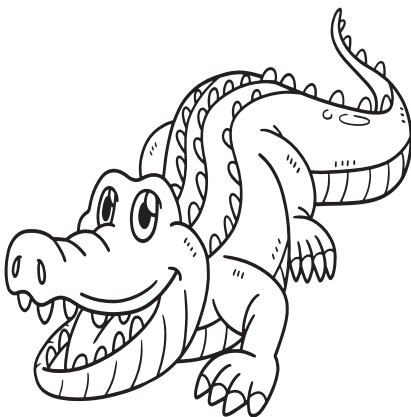
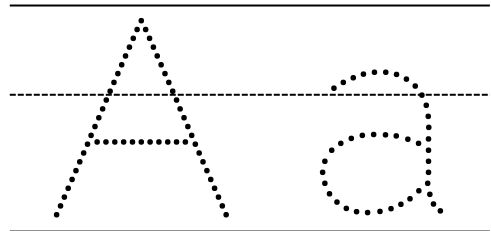
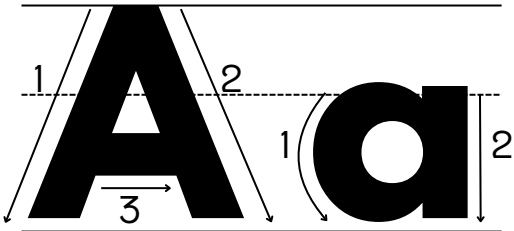
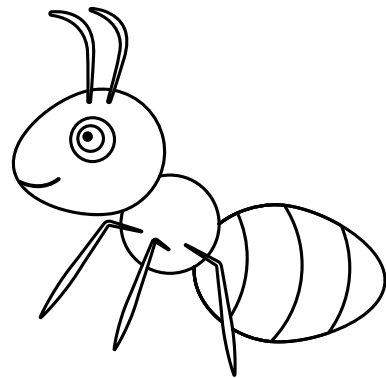
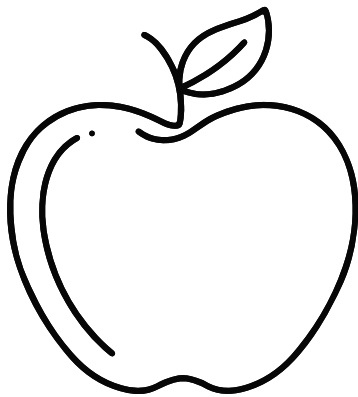
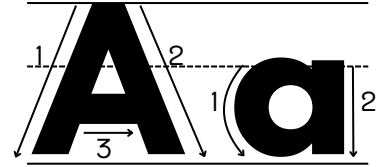

Name: _____

Letter Sounds

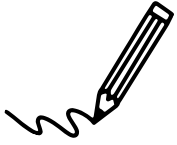

Directions: Color the picture, then trace the letter.

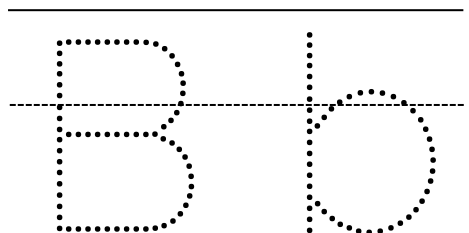
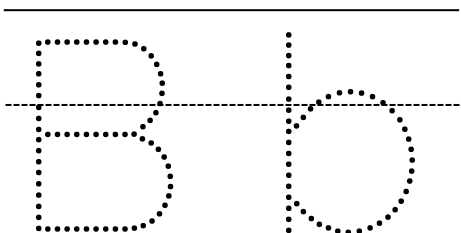
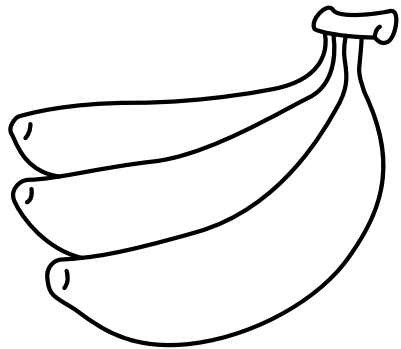
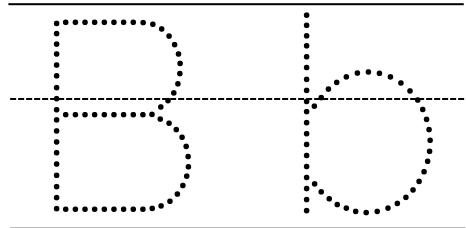
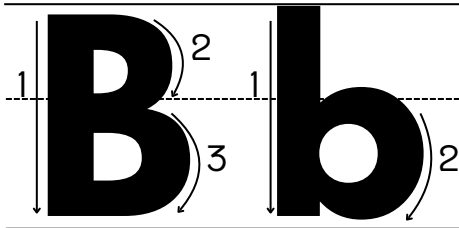
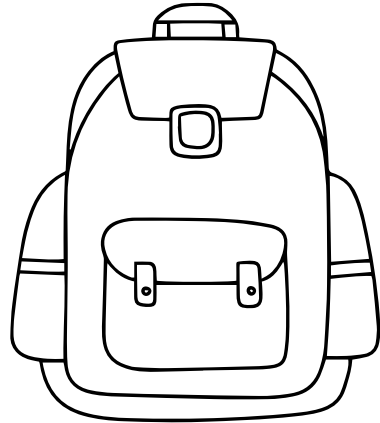
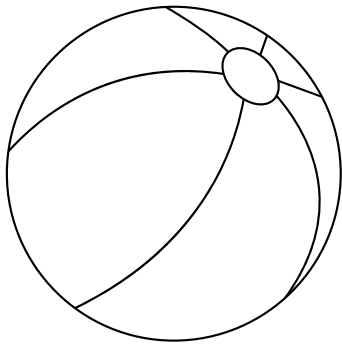
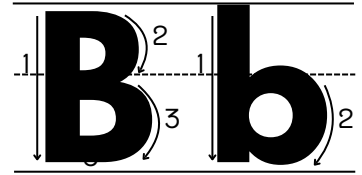

Name: _____

Letter Sounds



Directions: Color the picture,
then trace the letter.

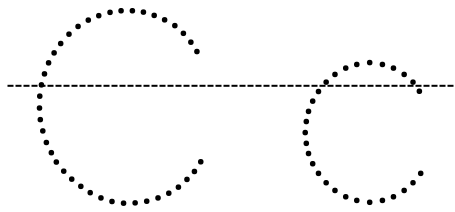
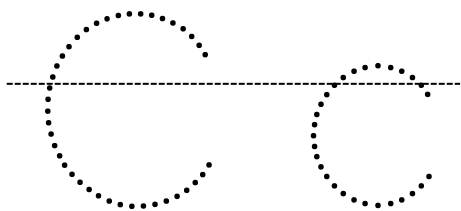
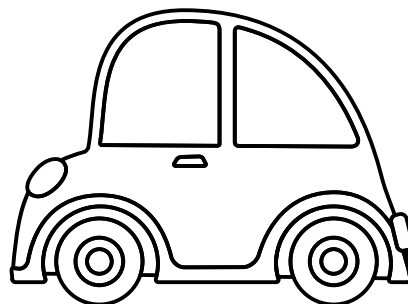
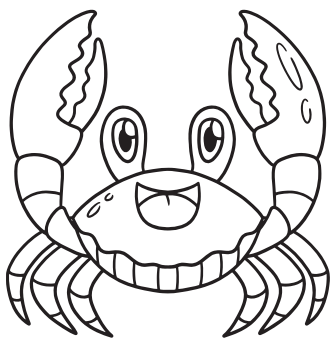
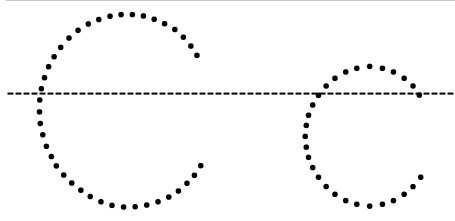
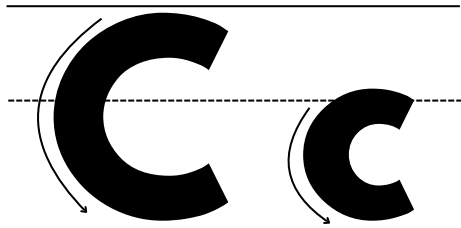
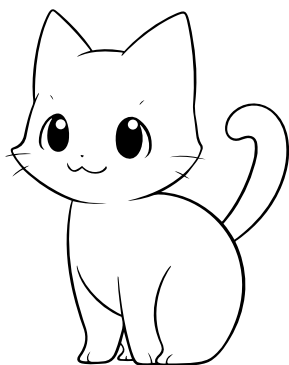
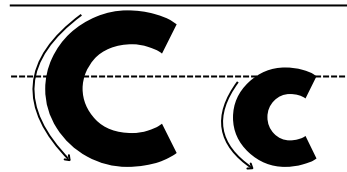

Name: _____

Letter Sounds



Directions: Color the picture, then trace the letter.

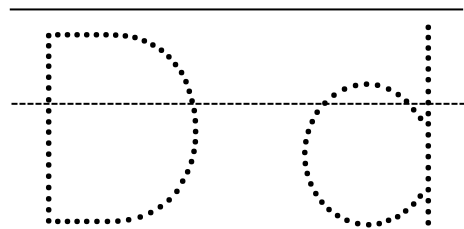
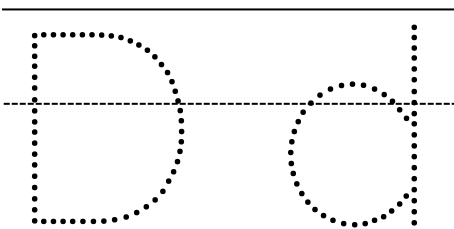
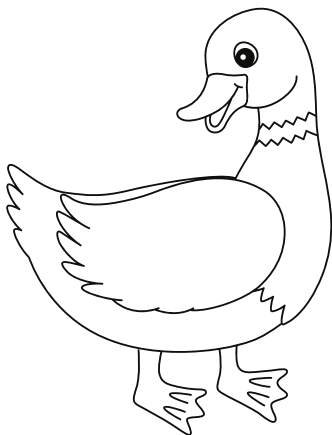
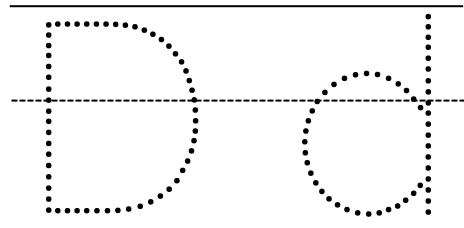
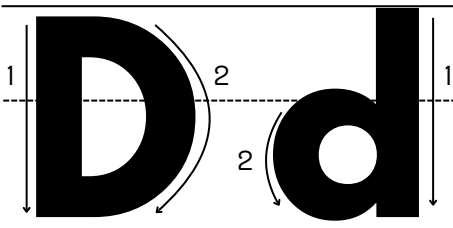
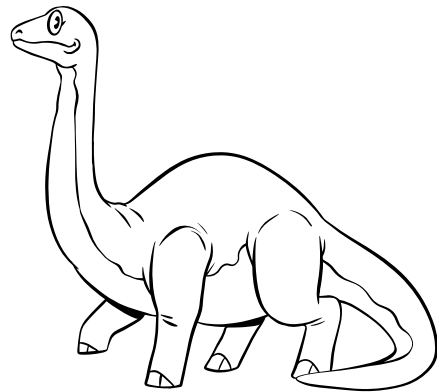
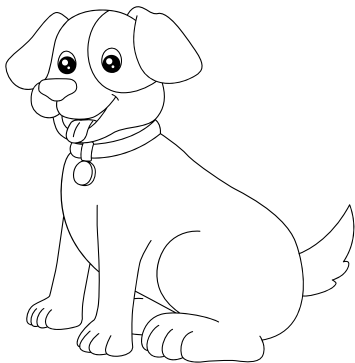
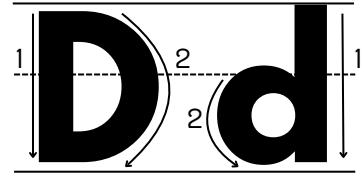

Name: _____

Letter Sounds



Directions: Color the picture, then trace the letter.

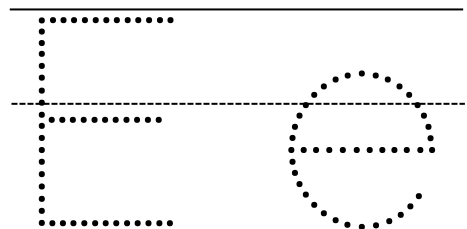
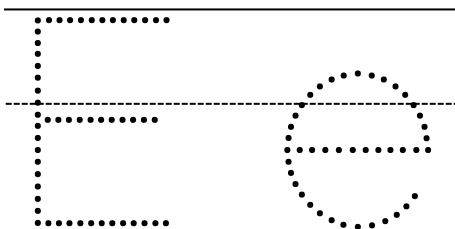
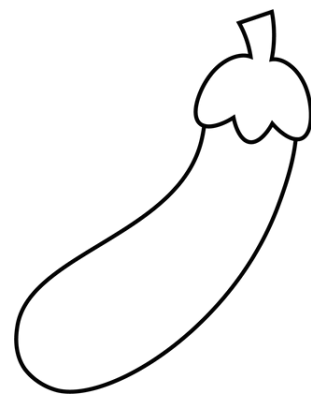
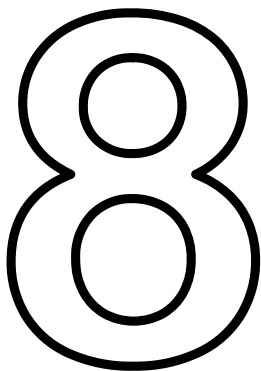
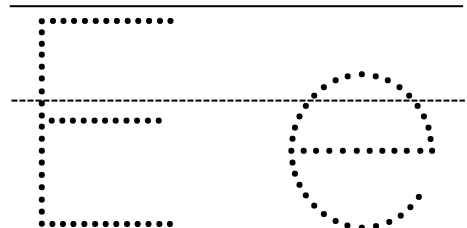
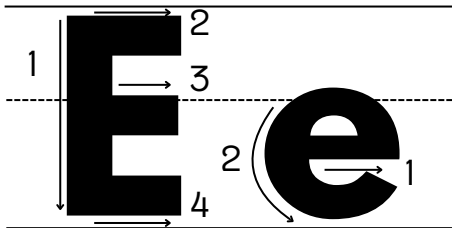
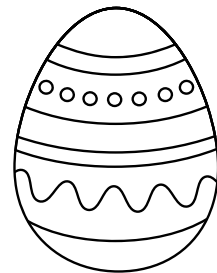
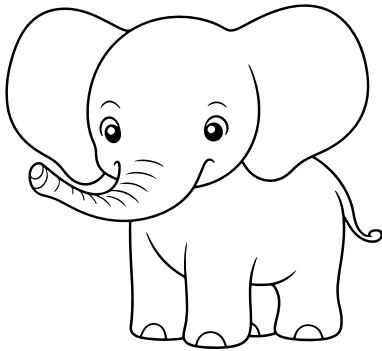
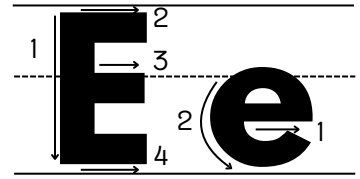

Name: _____

Letter Sounds



Directions: Color the picture, then trace the letter.

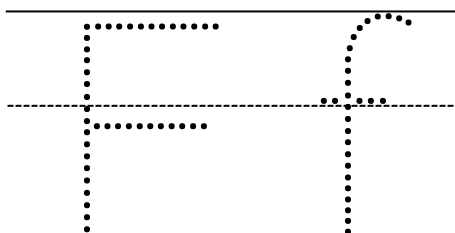
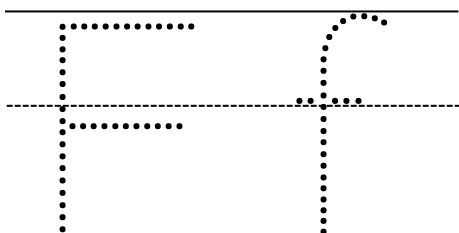
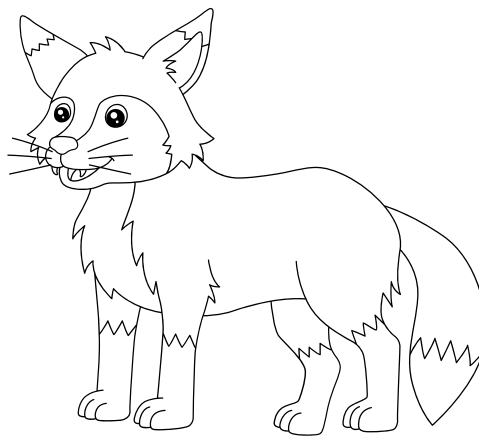
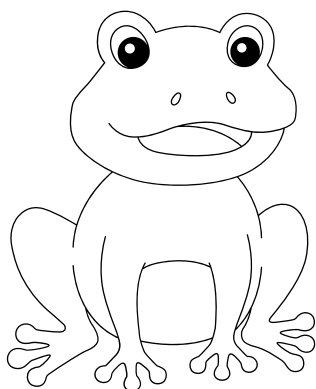
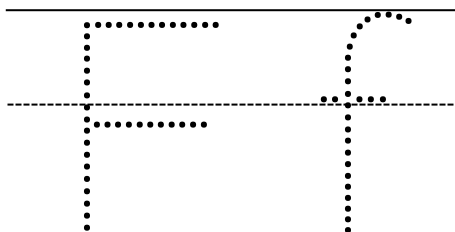
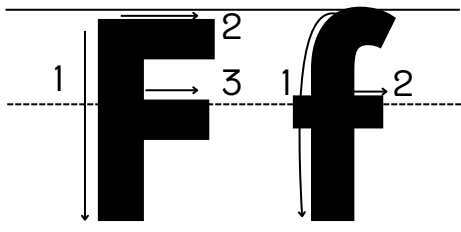
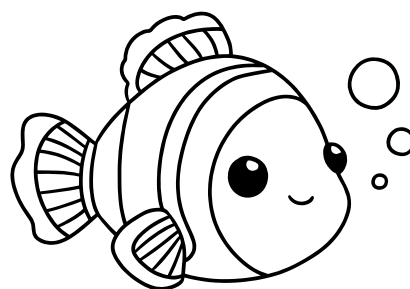
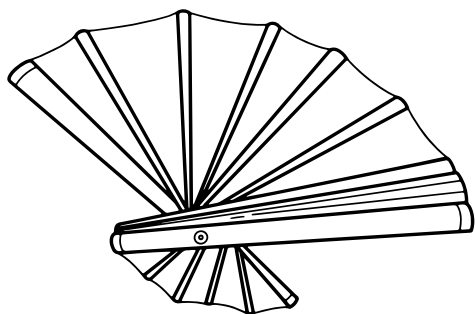
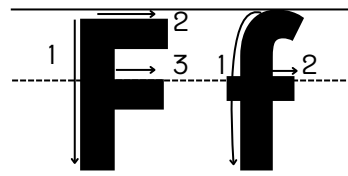

Name: _____

Letter Sounds



Directions: Color the picture, then trace the letter.

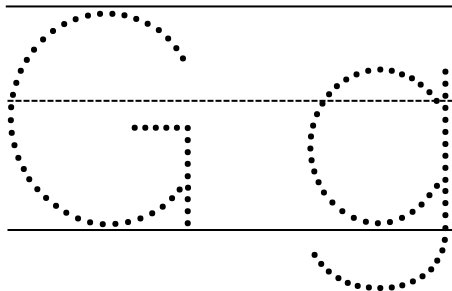
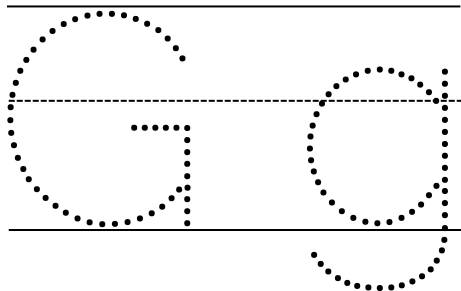
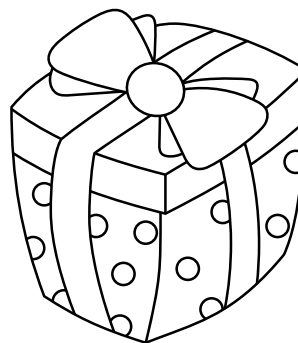
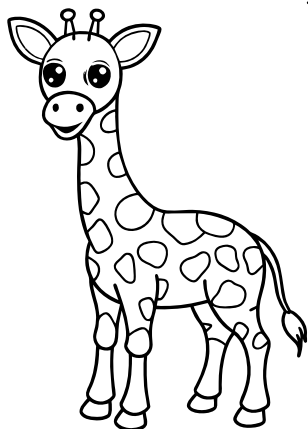
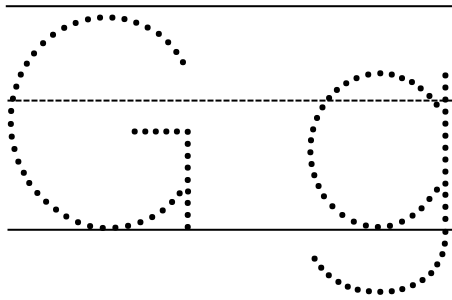
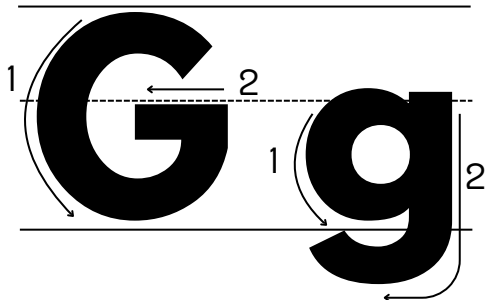
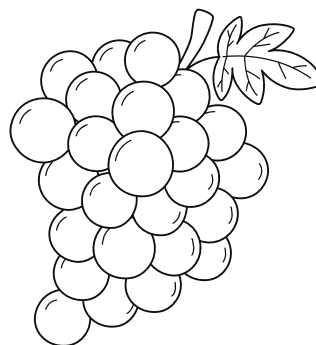
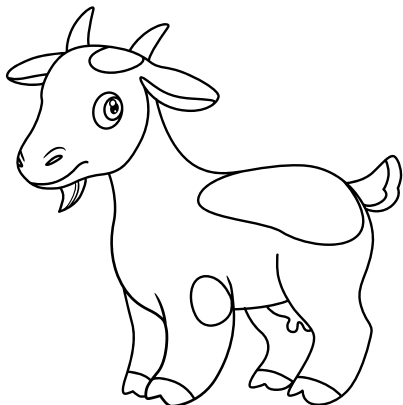
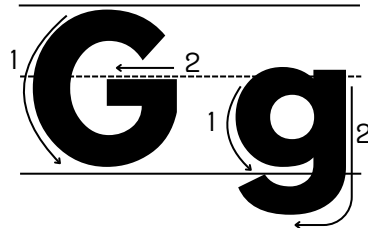

Name: _____

Letter Sounds



Directions: Color the picture, then trace the letter.

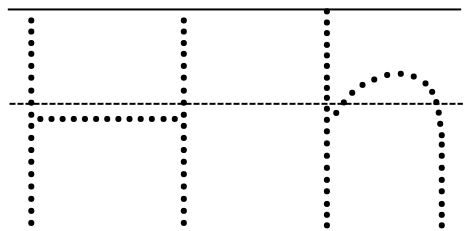
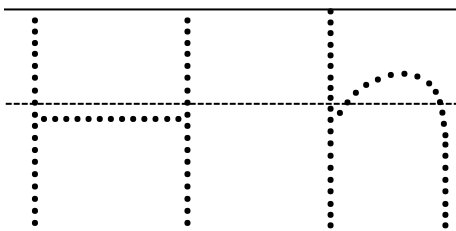
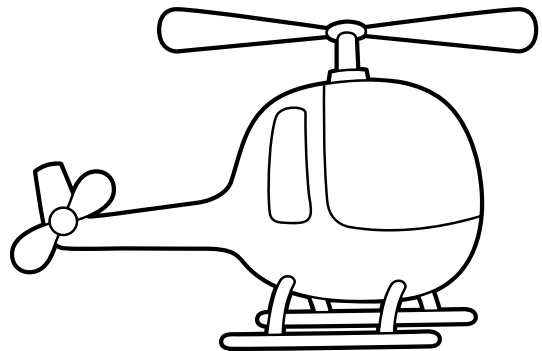
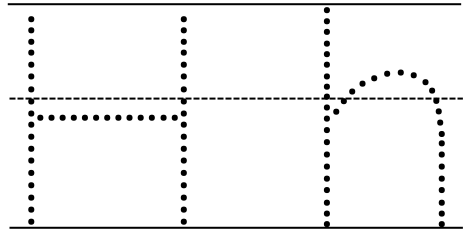
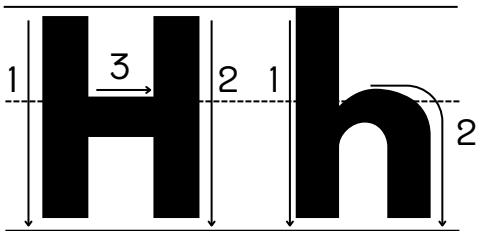
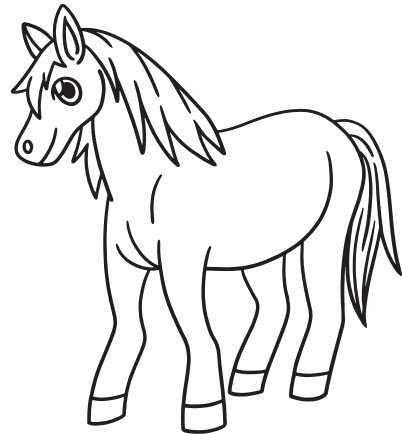
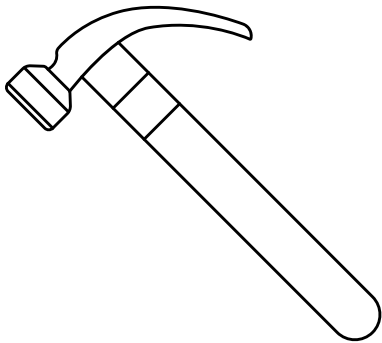
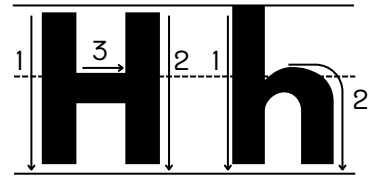

Name: _____

Letter Sounds

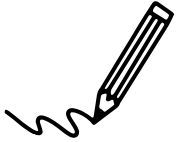

Directions: Color the picture, then trace the letter.

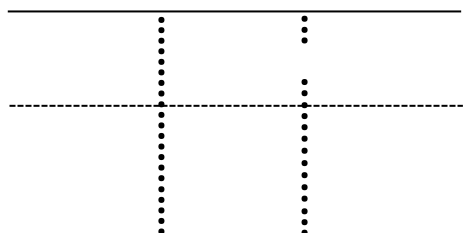
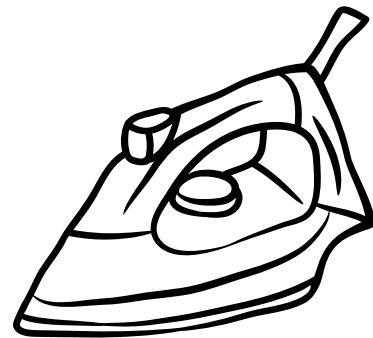
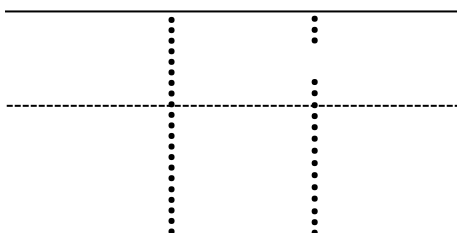
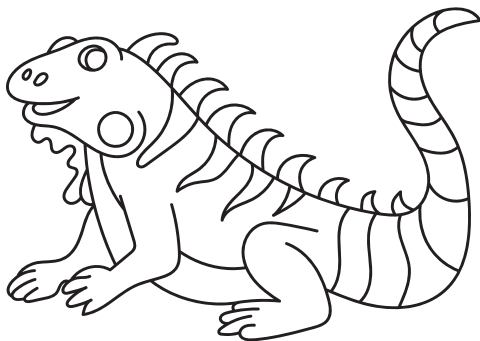
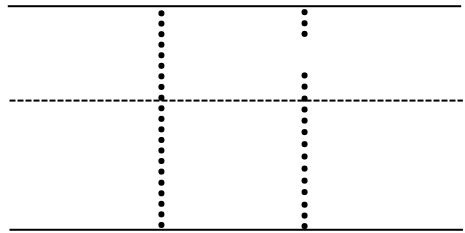
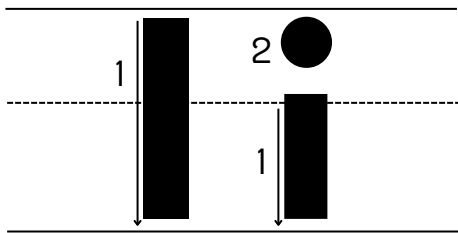
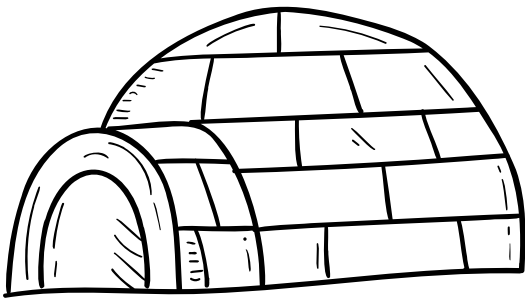
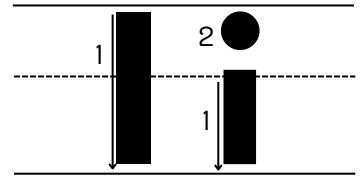

Name: _____

Letter Sounds

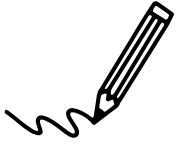

Directions: Color the picture,
then trace the letter.

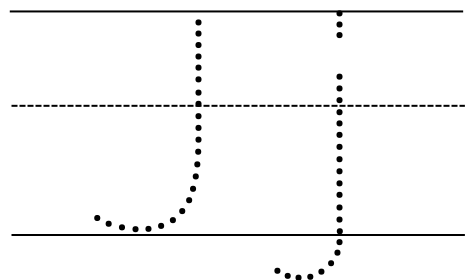
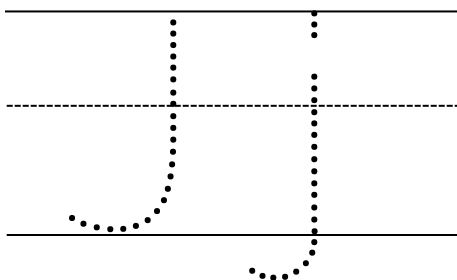
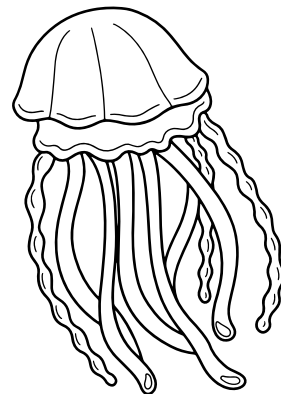
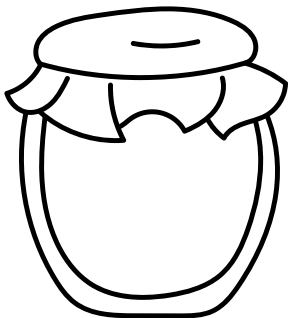
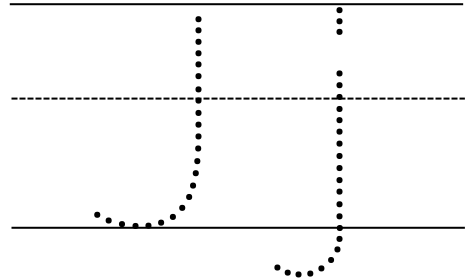
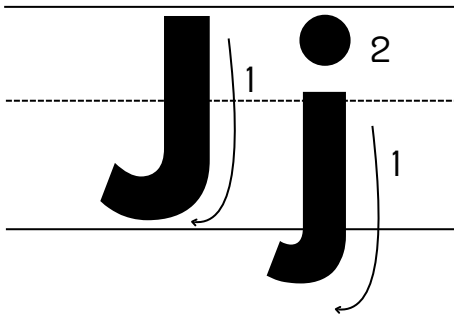
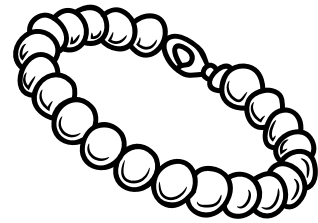
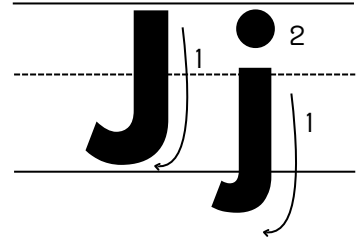

Name: _____

Letter Sounds

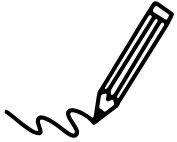

Directions: Color the picture, then trace the letter.

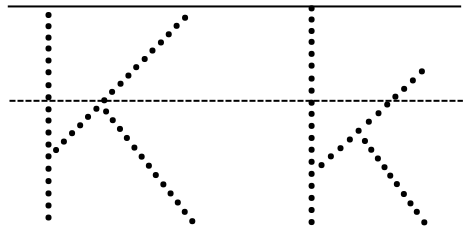
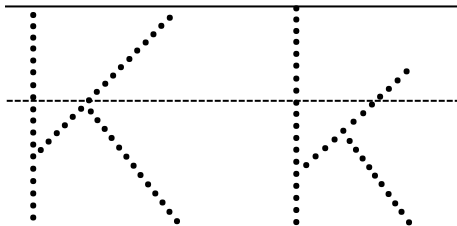
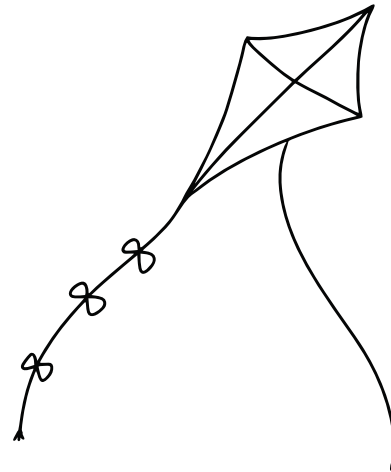
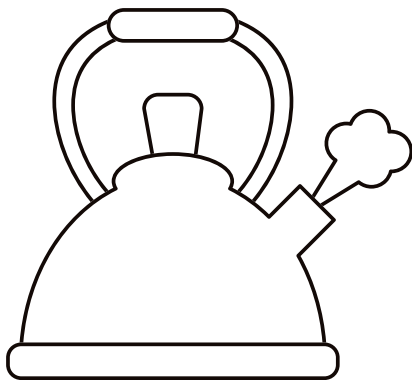
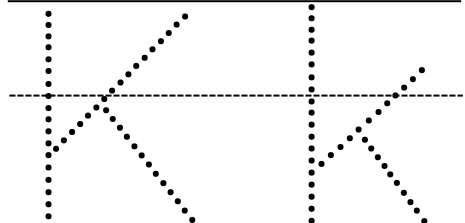
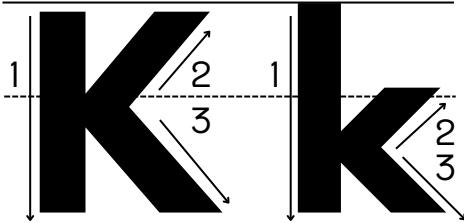
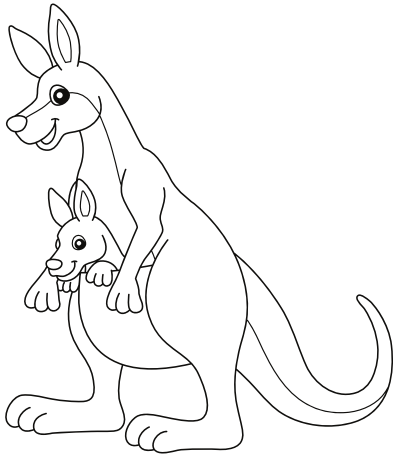
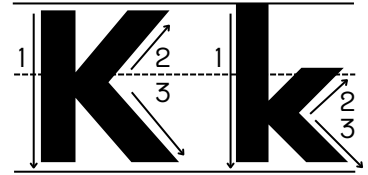

Name: _____

Letter Sounds

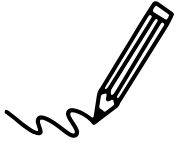

Directions: Color the picture, then trace the letter.

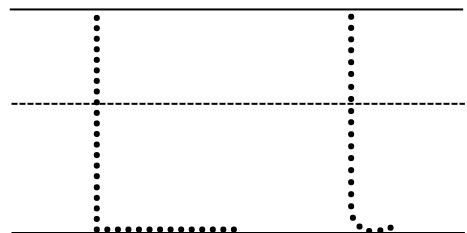
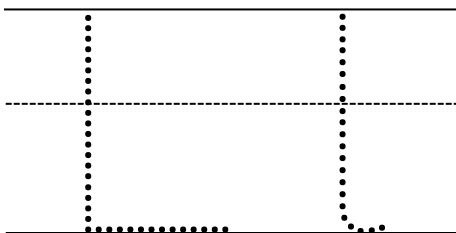
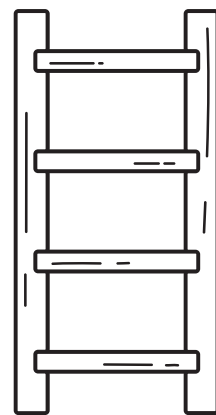
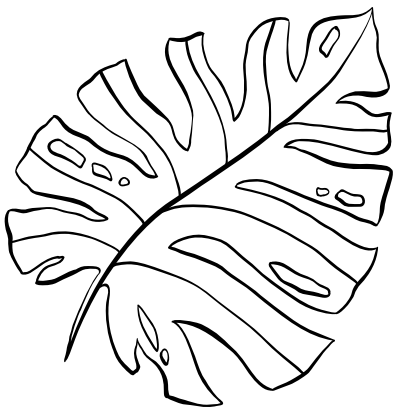
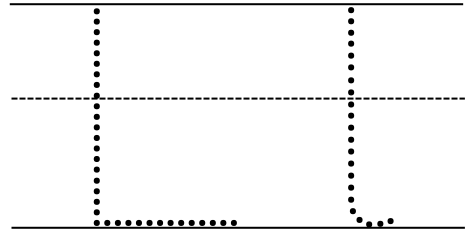
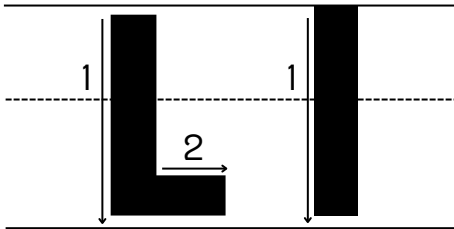
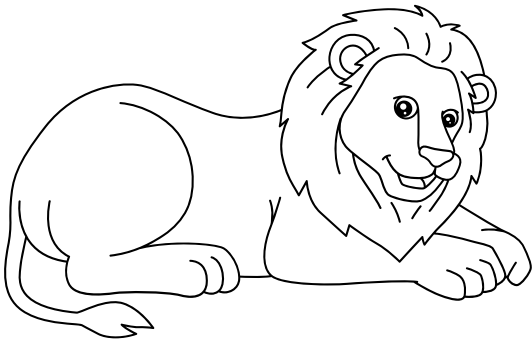
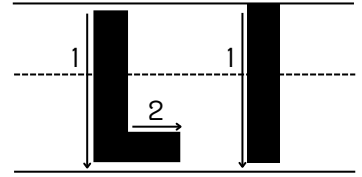

Name: _____

Letter Sounds

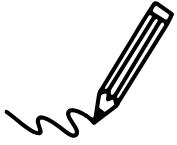

Directions: Color the picture, then trace the letter.

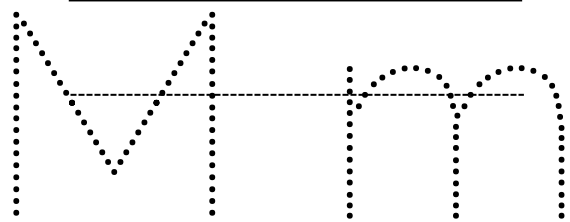
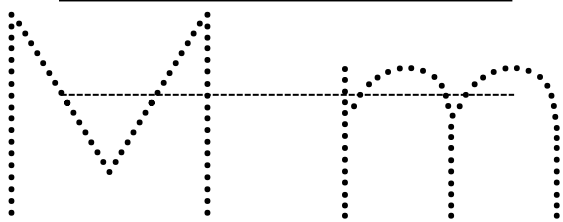
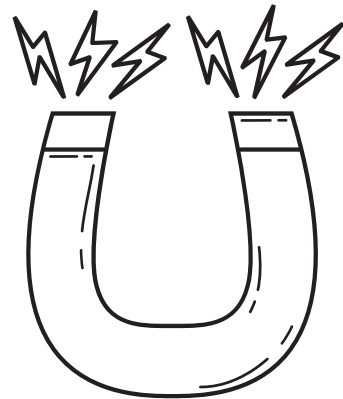
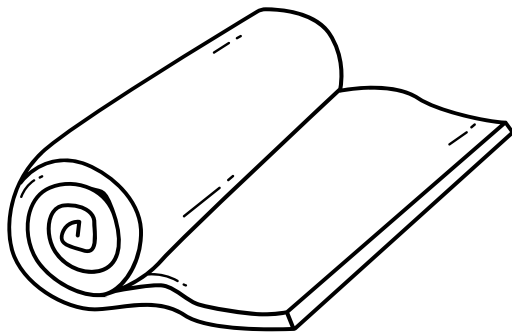
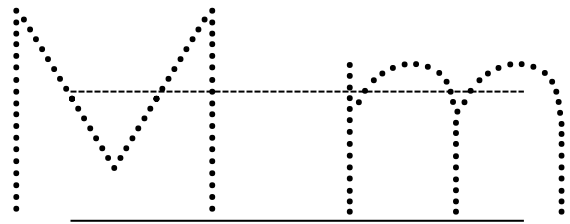
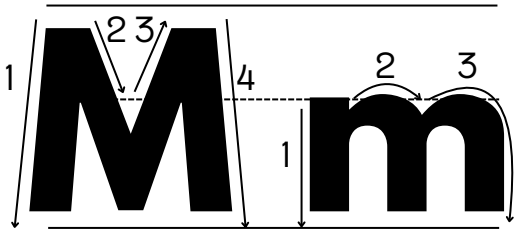
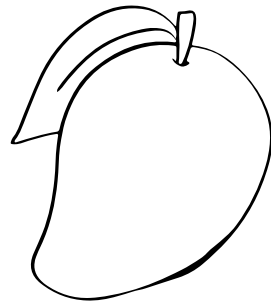
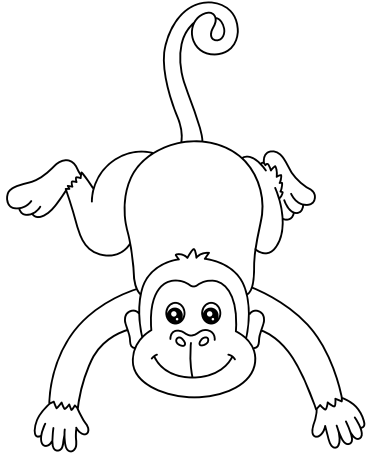
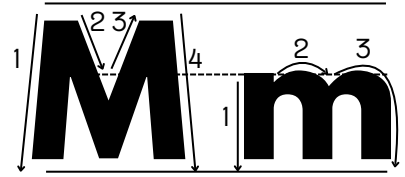

Name: _____

Letter Sounds



Directions: Color the picture, then trace the letter.

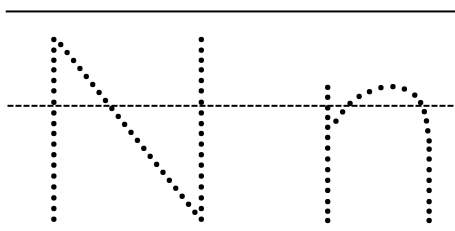
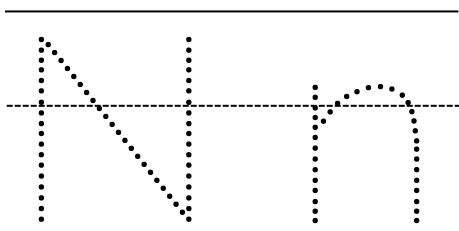
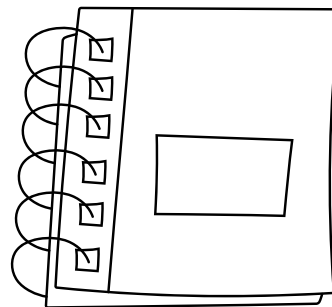
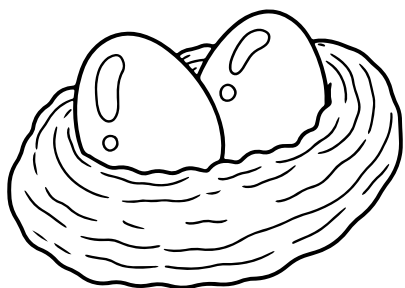
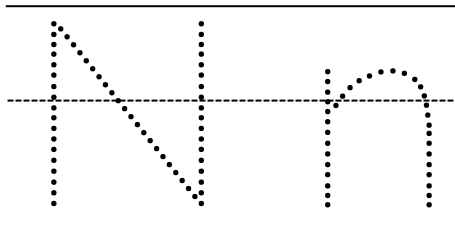
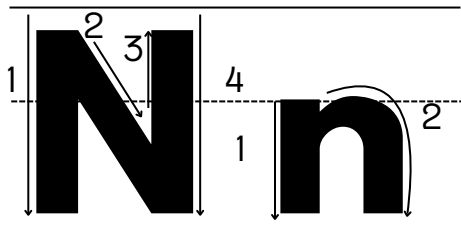
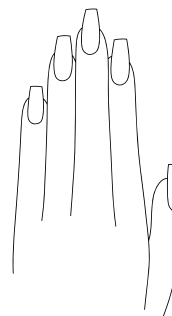
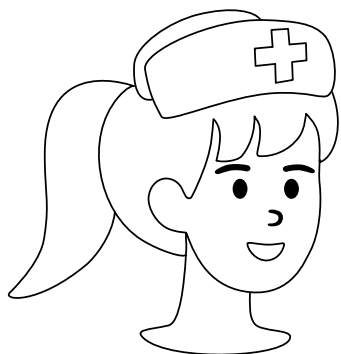
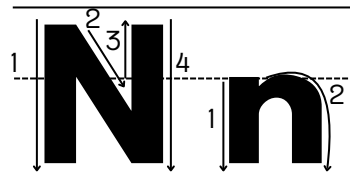

Name: _____

Letter Sounds



Directions: Color the picture, then trace the letter.

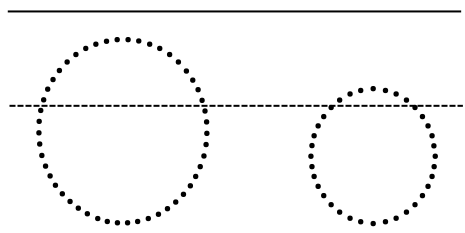
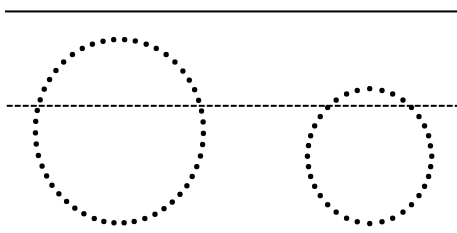
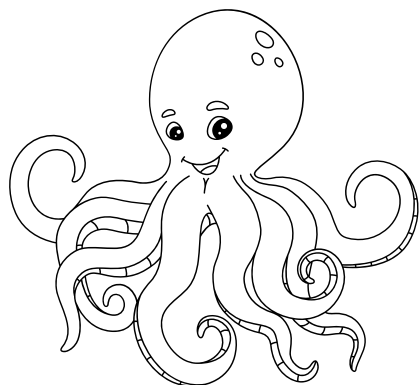
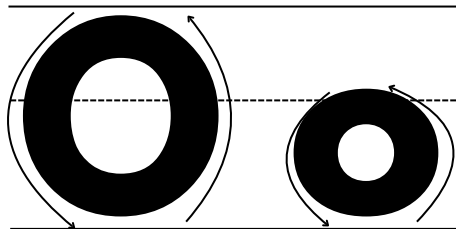
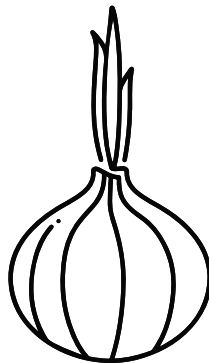
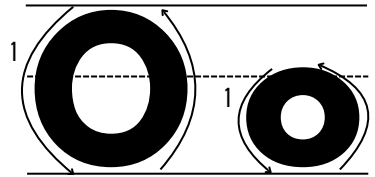

Name: _____

Letter Sounds

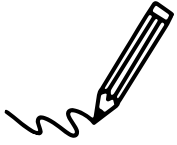

Directions: Color the picture, then trace the letter.

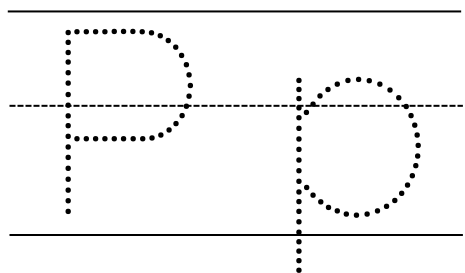
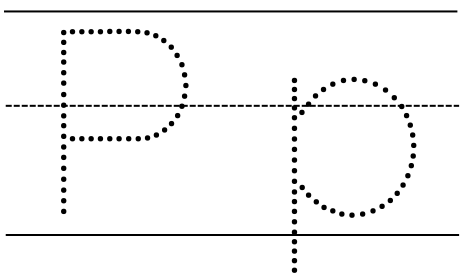
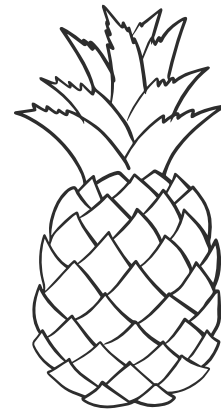
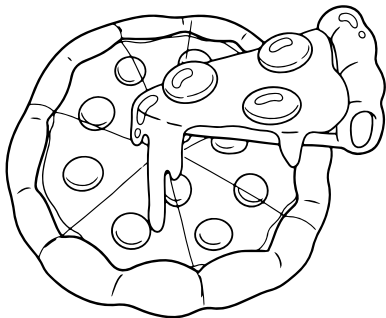
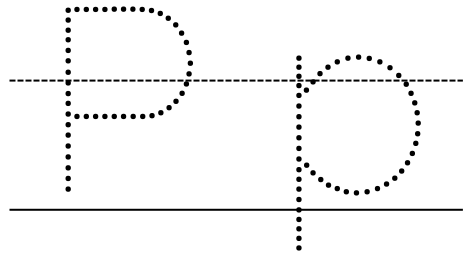
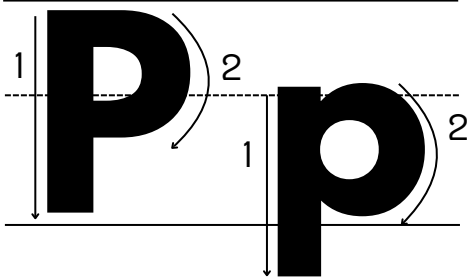
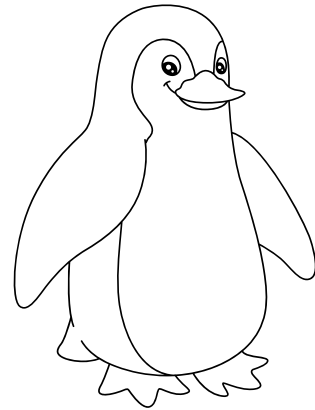
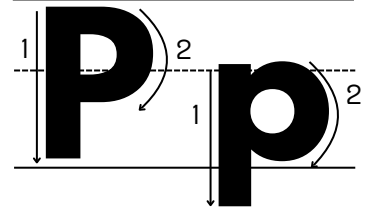

Name: _____

Letter Sounds

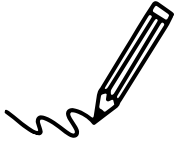

Directions: Color the picture, then trace the letter.

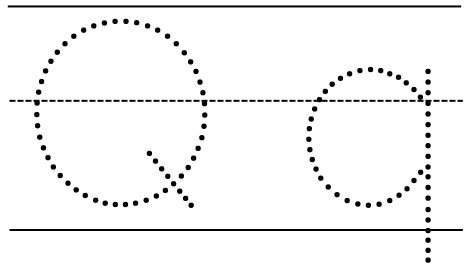
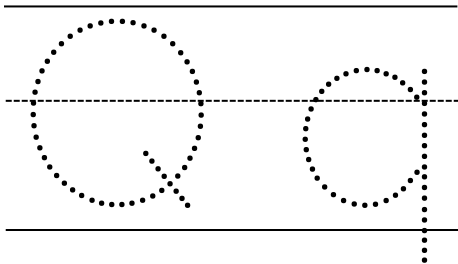
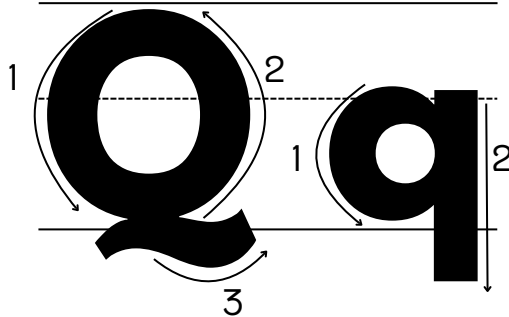
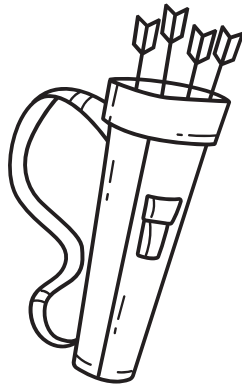
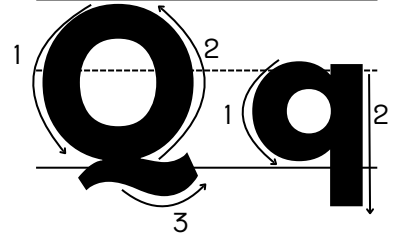

Name: _____

Letter Sounds



Directions: Color the picture, then trace the letter.

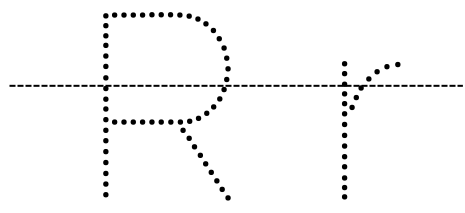
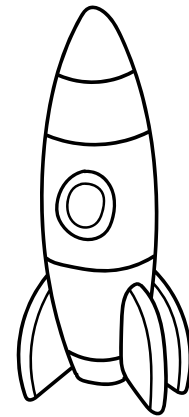
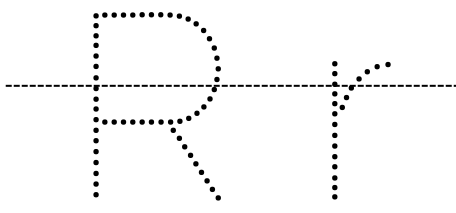
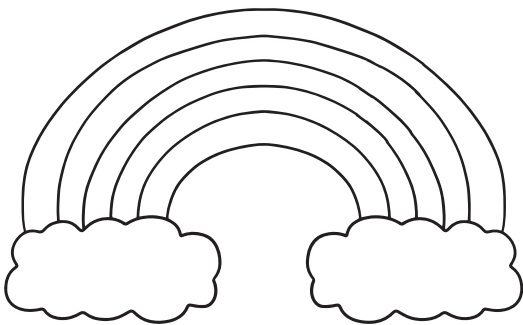
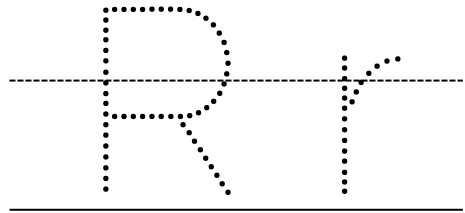
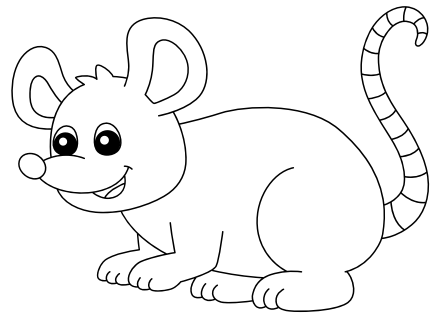
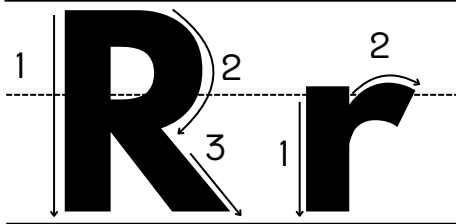
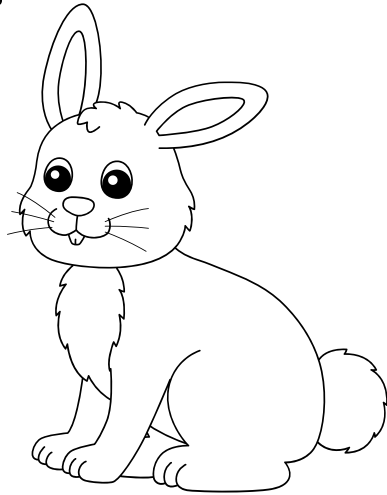
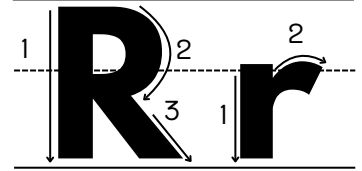

Name: _____

Letter Sounds

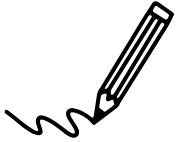

Directions: Color the picture,
then trace the letter.

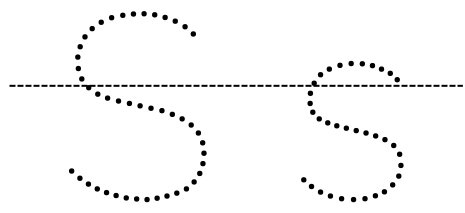
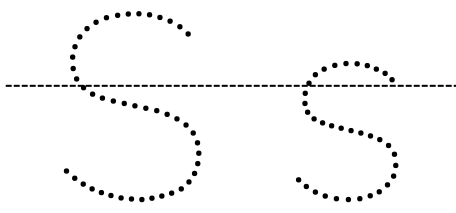
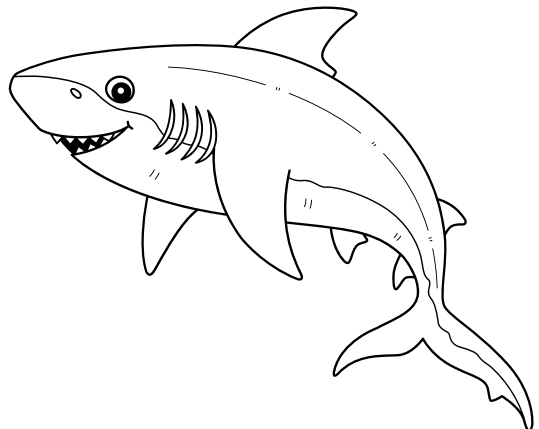
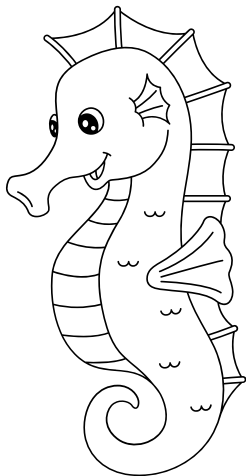
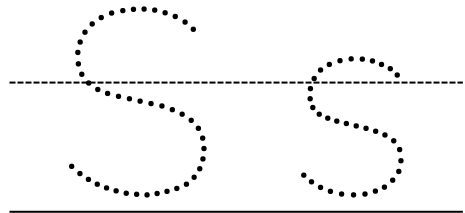
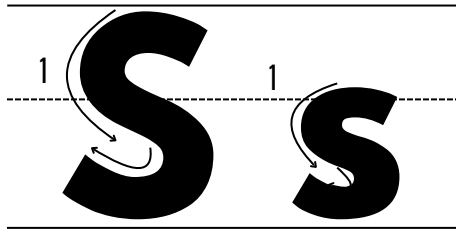
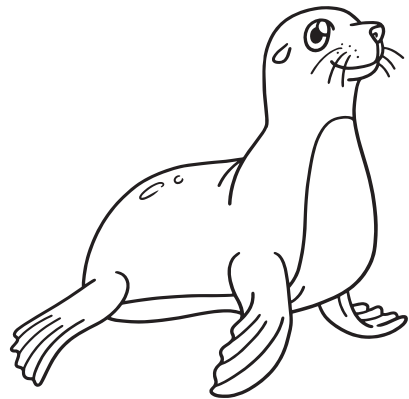
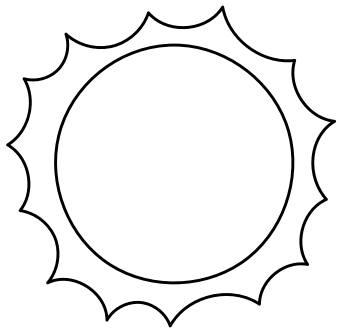
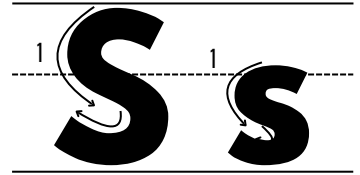

Name: _____

Letter Sounds



Directions: Color the picture, then trace the letter.

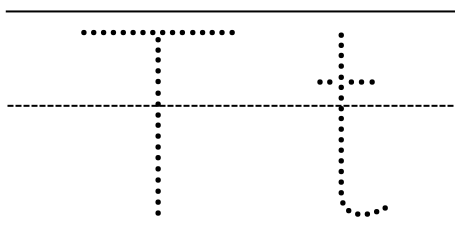
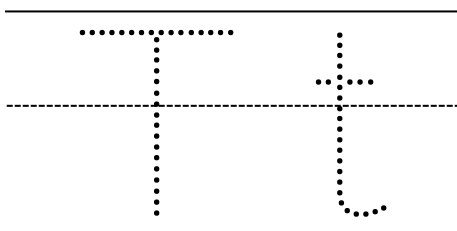
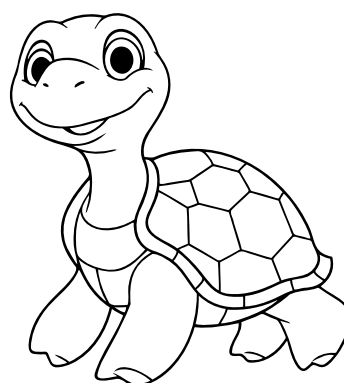
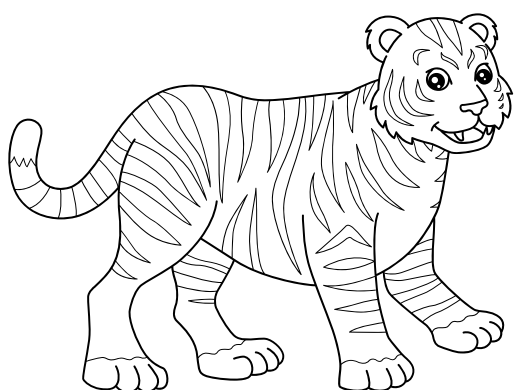
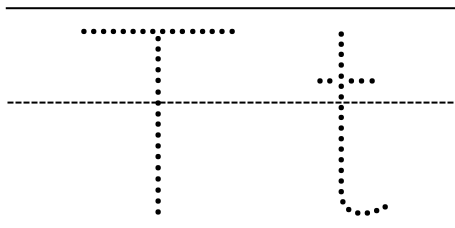
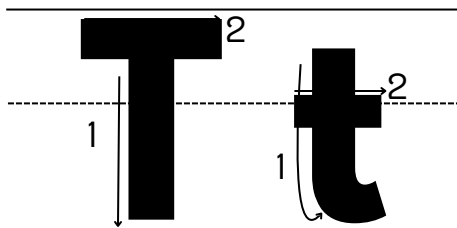
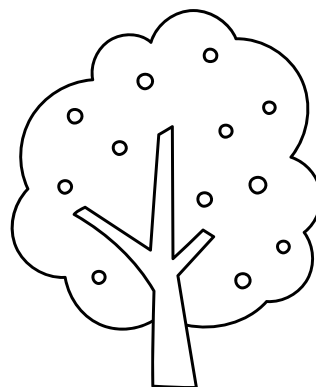
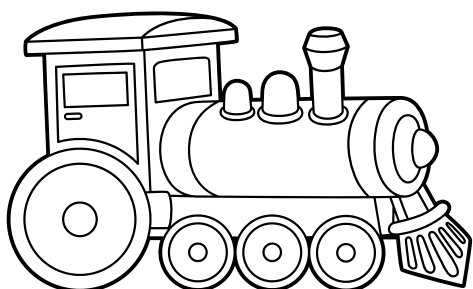
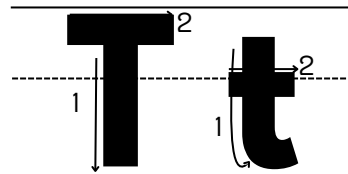

Name: _____

Letter Sounds

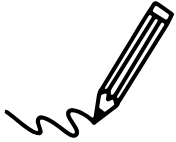

Directions: Color the picture,
then trace the letter.

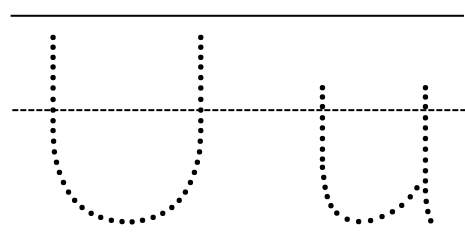
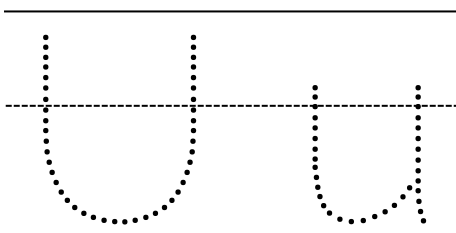
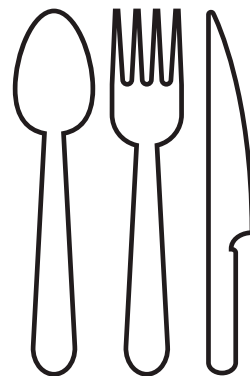
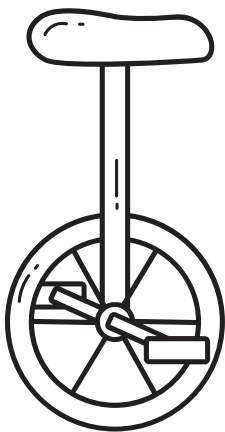
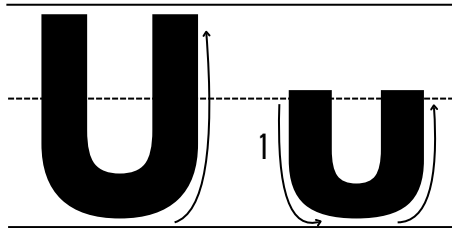
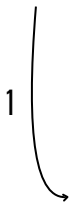
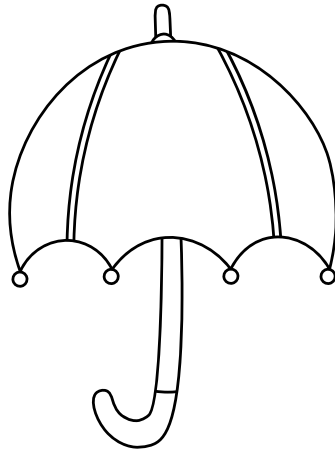
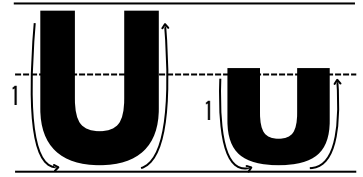

Name: _____

Letter Sounds



Directions: Color the picture, then trace the letter.

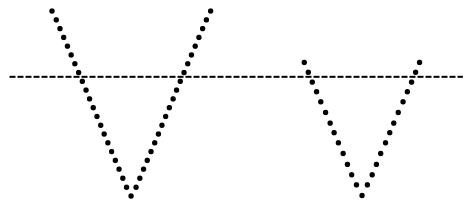
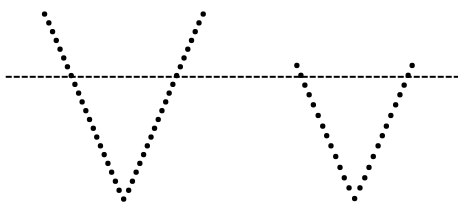
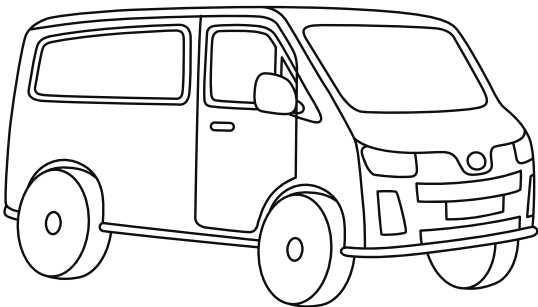
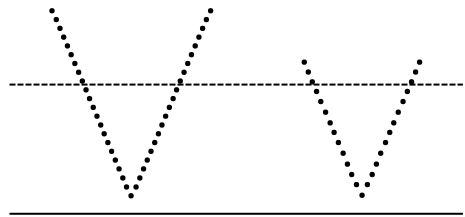
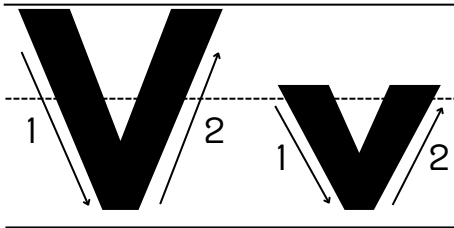
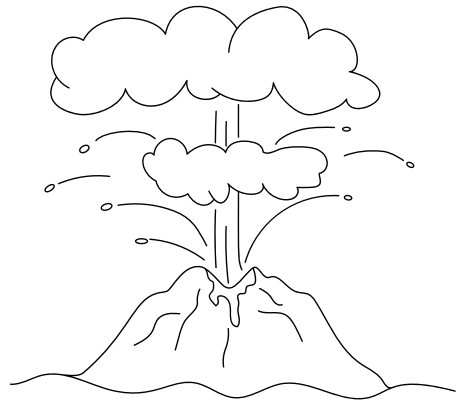
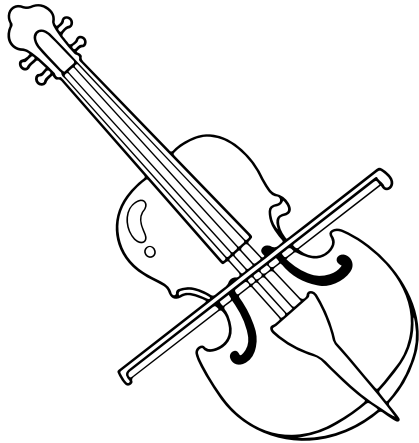
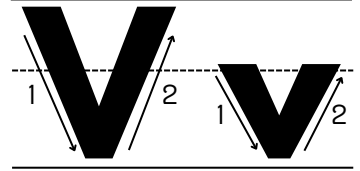

Name: _____

Letter Sounds



Directions: Color the picture, then trace the letter.

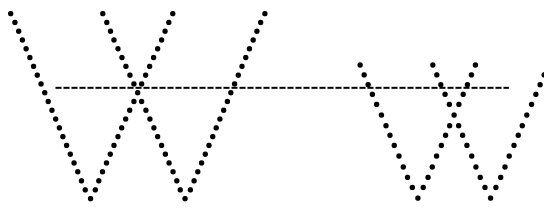
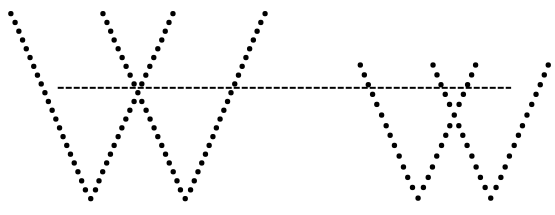
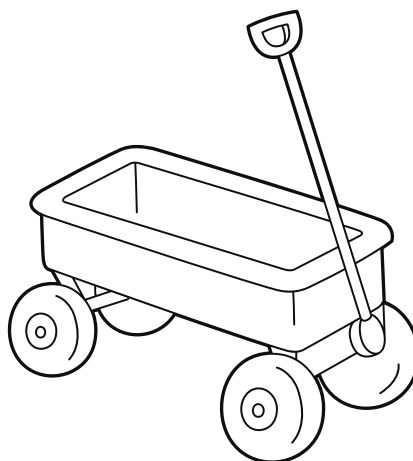
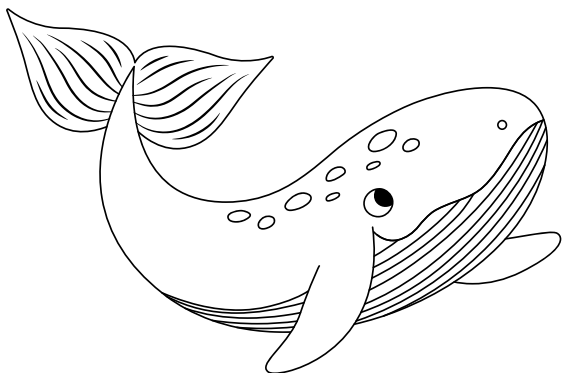
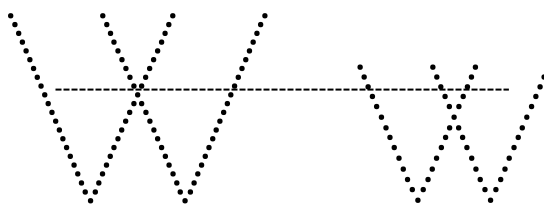
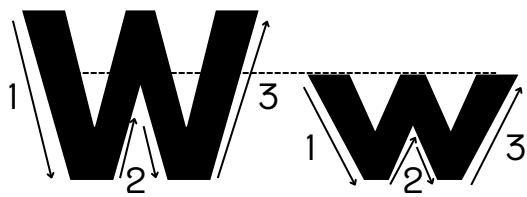
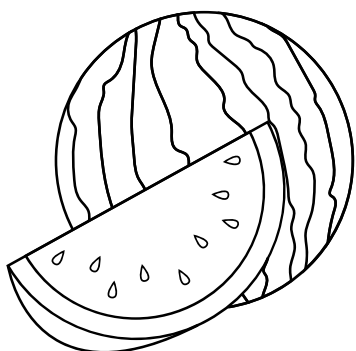
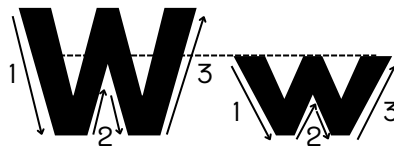

Name: _____

Letter Sounds

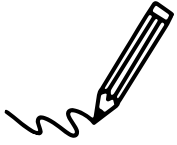

Directions: Color the picture, then trace the letter.

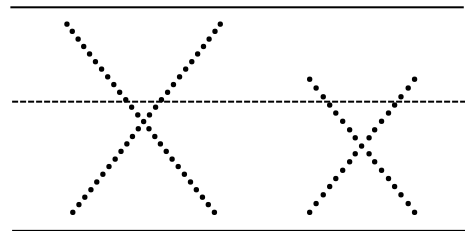
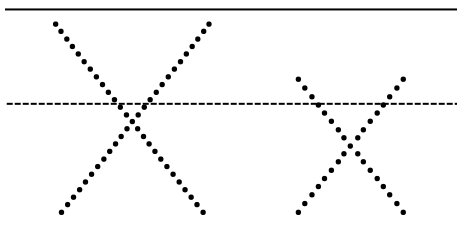
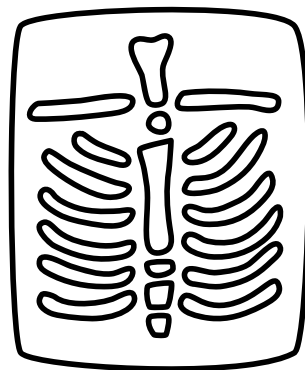
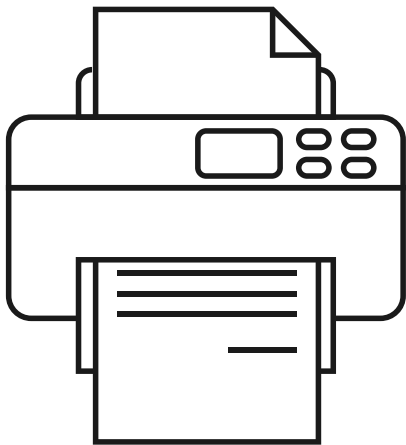
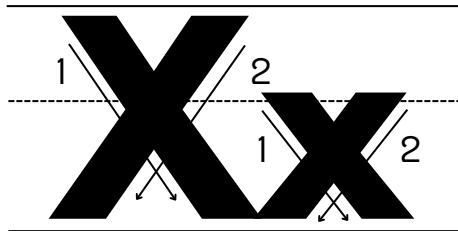
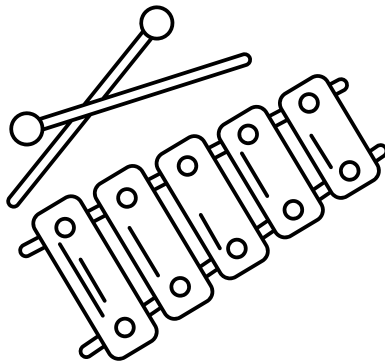
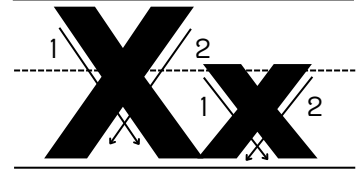

Name: _____

Letter Sounds

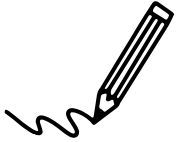

Directions: Color the picture, then trace the letter.

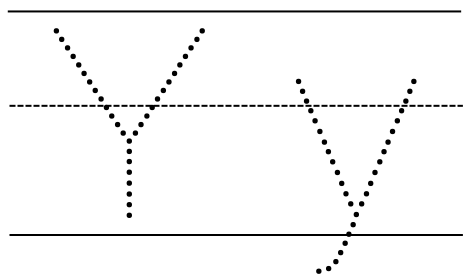
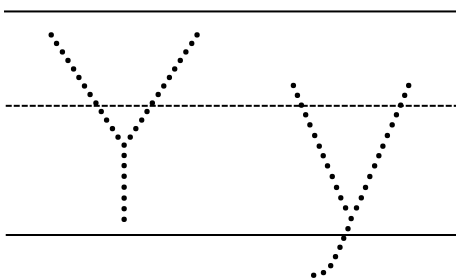
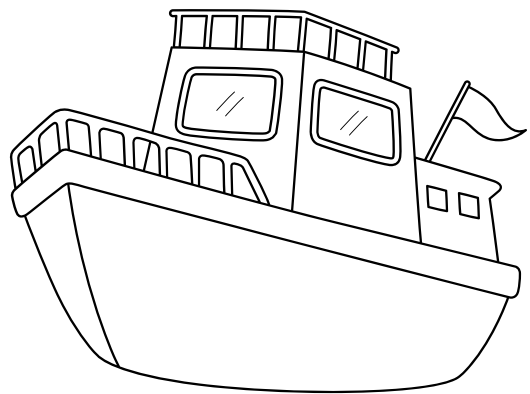
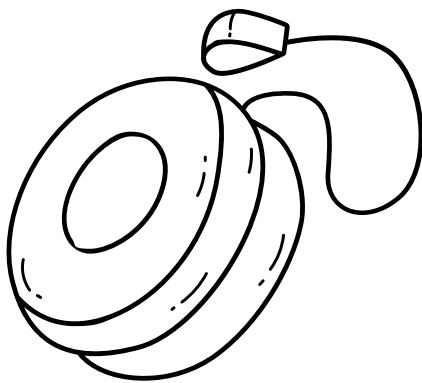
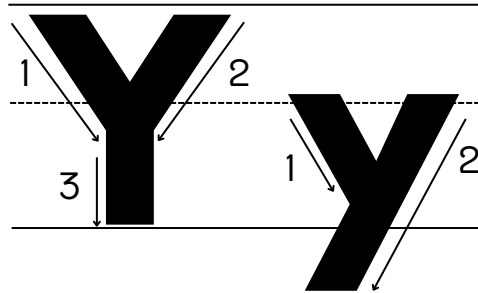
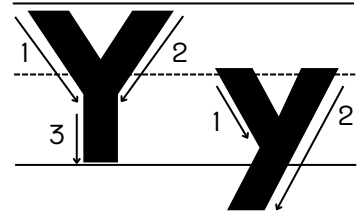

Name: _____

Letter Sounds

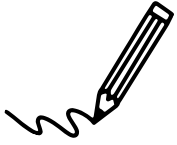

Directions: Color the picture, then trace the letter.

